

2025 GROTE PRIJSGIDS - €



OVERZICHT

1. Machines: Specificaties en prijzen	
Kleine klussen	6 - 9
Fijne Afwerkingstoepassingen	10 - 13
Professionele airless toepassingen	14 - 23
Airless structuurtoepassingen	24 - 35
Heavy Duty toepassingen	36 - 41
Professionele Reinigingstoepassingen	42 - 43
Wegmarkering	44 - 49
Oppervlaktevoorbereiding	50 - 51
2. Toebehoren: Specificaties en prijzen	
Kleine klussen	54 - 57
Fijne Afwerkingstoepassingen	58 - 62
Professionele airless toepassingen	63 - 87
Airless structuurtoepassingen	88 - 95
Heavy Duty toepassingen	96 - 97
Professionele Reinigingstoepassingen	98 - 99
Algemene Onderdelen	100 - 101
3. Tips: Specificaties en prijzen	
Selectiehulp tips	102 - 107
Fijne afwerkingtips, lage druk	108 - 109
Rac® X Tips	110 - 111
Platte Tips	112 - 113
Wegmarkeringstips	114
Reinigingstips	115
4. Garantie	
Garantie	116 - 119
5. Ondersteuningsmateriaal	
Commerciële literatuur & service informatie	120 - 125

MACHINES

SPECIFICATIES & PRIJZEN



Het ultieme 'snel-zoek' overzicht!

Vergelijk hier technische kenmerken, aanwezige technologieën
alsook de standaard configuratie van alle producten uit een bepaalde
toepassingsgroep – alles in 1 overzicht.

SPECIFICATIES & PRIJZEN

KLEINE KLUSSEN - 1

ULTRA®
AIRLESS
HANDHELD AC



ULTRA®
AIRLESS
HANDHELD DC



ULTRAMAX
AIRLESS
HANDHELD DC



TECHNISCHE GEGEVENS			
Artikelnummers: EU, IT, DK, CH - 230V	17M360	17M366	17P258
Artikelnummers: UK - 230V	25M616	25M615	25M614
Max. tipgrootte	0.016"	0.016"	0.016"
Motor	AC	DC	DC zonder koolstofborstels
Max. druk - bar (PSI)	138 (2000)	138 (2000)	138 (2000)
Gewicht - kg (lbs)	2.1 (4.6)	2.4 (5.3)	2.4 (5.3)
KENMERKEN			
Materiaal- en oplosmiddelcompatibiliteit	Op waterbasis	Op waterbasis	■*
Repareerbaar	■	■	■
SmartControl™	■	■	■
Snelheidscontrole	ProControl™ II	ProControl™ II	ProControl™ II
Aanzuigsysteem	Vacuüm	Vacuüm	Vacuüm
Bekersysteem	Wegwerp	Wegwerp	Wegwerp
SAMENSTELLING			
Tips	FFLP410 + FFLP514		
Tiphouder	RAC X™ - 246215	RAC X™ - 17P573	
Filter (maasgrootte)	60 + 100		
Stroomvoorziening	3m stroomkabel	2 x 18V DEWALT® batterij**	
Batterijlader		■	■
Beker + deksel	1 L (1 beker, 1 deksel)		
Bekerkzakjes	4		
Quickkill Trechter en zeef	■	■	■
Opberg -tas/-koffer	Tas		
PRIJZEN			
	17M360: € 720,00	17M366: € 890,00	17P258: € 1.020,00
	25M616: € 720,00	25M615: € 890,00	25M614: € 1.020,00
BROCHURE			
	3J0545	3J0545	3J0545

* Compatibel met "brandbare" en "warme" oplosmiddelen; raadpleeg de gebruikershandleiding voor een gedetailleerde lijst van compatibele reinigingsvloeistoffen.

** DEWALT® en het DEWALT-logo zijn handelsmerken van DEWALT Industrial Tool Co. en worden onder licentie gebruikt.





SPECIFICATIES & PRIJZEN

KLEINE KLUSSEN - 2

ULTRA®
QUICKSHOT™



TECHNISCHE GEGEVENS	
Artikelnummers: EU, IT, DK, CH - 230V	20B476
Artikelnummers: UK - 230V	20B475
Max. tipgrootte	0.016"
Motor	DC zonder koolstofborstels
Max. druk - bar (PSI)	138 (2000)
Gewicht - kg (lbs)	2.9 (6.4)
KENMERKEN	
Materiaal- en oplosmiddelcompatibiliteit	■*
Repareerbaar	■
SmartControl™	■
Snelheidscontrole	Debietregeling op pistool
Aanzuigstelsel	Zwaartekrachtaanvoer
Bekersysteem	1L Pour-N-Go Vulbeker
SAMENSTELLING	
Pistool	Elektrisch aangedreven instant-responsepistool
Slang	1/8" x 1.8m flexibele slang
Tips	FFLP410 + FFLP514
Tiphouder	RAC X - 246215
Filter (maasgrootte)	60 + 100
Hands-free holsterbevestiging en riem	■
Stroomvoorziening	2 x 18V DEWALT® batterij**
Batterijlader	■
Opberg-tas/-koffer	Tas
PRIJZEN	
	20B476: € 1.490,00
	20B475: € 1.490,00
BROCHURE	
	3J0545

* Compatibel met "brandbare" en "warme" oplosmiddelen; raadpleeg de gebruikershandleiding voor een gedetailleerde lijst van compatibele reinigingsvloeistoffen.
** DEWALT® en het DEWALT-logo zijn handelsmerken van DEWALT Industrial Tool Co. en worden onder licentie gebruikt.

SPECIFICATIES & PRIJZEN

FIJN AFWERKINGSGAMMA - 1



TECHNISCHE GEGEVENS	HVLPTM STANDARD		HVLPTM PROCONTRACTOR		HVLPTM PROCOMP
	9.0	7.0	9.5		9.5
Artikelnummers: EU - 230V	17P529	17P530	17P532		17P533
Artikelnummers: IT, DK, CH, UK - 230V	17P535	17P536	17P538		17P539
Artikelnummers: UK - 110V	-	-	17T982		-
Turbine stages	4	3	5		5
Max. luchtdruk - bar (PSI)	0.6 (9)	0.5 (7)	0.7 (9.5)		0.7 (9.5)
Gewicht - kg (lbs)	14 (30.8)	18 (39.7)	19 (41.9)		23 (50.7)
KENMERKEN					
TurboForce™ II technologie	■	■	■		■
SmartStart		■	■		■
TCS Systeem	■	■	■		■
Naalden met snelkoppeling "Quickrelease"	■	■	■		■
Flex Liner Systeem	■	■	■		Externe beker
Luchtregeling aan het pistool	Vooraf ingesteld	■	■		■
Materiaalregeling aan het pistool	■	■	■		■
Spuitbeeldregeling aan het pistool	■	■	■		■
Opberging materiaalset		■	■		■
Afwasbare luchtfilter	Schuim	Automobiel	Automobiel		Automobiel
SAMENSTELLING					
Materiaalsets	#3	#3	#3, #4, #5		#3, #4, #5
Pistool	EDGE® II	EDGE® II Plus			EDGE® II Plus
Slang	Super-Flex™ Air 6M - 17R300	Super-Flex™ Air 9M - 257159			Super-Flex™ Air 9M - 257159
Hulp slang		Super-Flex™ Air 1.2M - 17R299			Super-Flex™ Air 1.2M - 17R299
Pistool & Beker houder		■			■
PRIJZEN					
	17P529: € 2.075,00	17P530: € 2.210,00	17P532: € 2.810,00		17P533: € 3.715,00
	17P535: € 2.075,00	17P536: € 2.210,00	17P538: € 2.810,00		17P539: € 3.715,00
			17T982: € 2.835,00		
BROCHURE	300744	300744	300744		300744



SPECIFICATIES & PRIJZEN

FIJN AFWERKINGSGAMMA - 2

FINISHPRO™ II

395 PC

595 PC PRO







TECHNISCHE GEGEVENS		
Artikelnummers: EU - 230V	17C418	17E912
Artikelnummers: IT, DK, CH - 230V	17C421	17E913
Artikelnummers: UK - 110V	17C320	-
Max. tipgrootte: 1 pistool	0.023"	0.027"
Max. debiet - l/min (gpm)	2.0 (0.54)	2.6 (0.68)
Max. druk - bar (PSI)	227 (3300)	227 (3300)
Motor type - kW (HP)	0.65 (0.875) TEFC Koolstofborstels DC	1.19 (1.6) Zonder koolstofborstels DC
Turbine / kompressor l/min (cfm)	2.0 (0.47)	2.7 (0.7)
Max. luchtdruk - bar (PSI)	2.4 (35)	2.4 (35)
Gewicht - kg (lbs)	50 (110)	51 (112)
KENMERKEN		
LED Display		■
SmartControl™	1.0	3.0
Luchtdruk meter	■	■
FastFlush™		■
ProGuard™		■
Endurance™ Pomp	■	■
ProConnect™	■	■
SmartComp™	■	■
Slanghouder	■	■
TiltBack™		■
SAMENSTELLING		
Tips	FFLP210 + LTX517 + AAM309	
Ombouwset (plat naar RAC®)	■	
Pistoolfilter (maasgrootte)	100 - 224453	
Pomppfilter (maasgrootte)	Easy Out™ 100 - 246382	
Pistool	G40 - 262932	
Slang	Super-Flex Materiaal+Lucht; Slang (7.5M)+Hulp slang (2M) 24U578; Slangbescherming 24U576	Super-Flex™ Materiaal+Lucht; Slang (15M)+Hulp slang (2M) 24U579; Slangbescherming 24U577
Hulp slang		
Gereedschapskist	■	
Gereedschap	■*	
PRIJZEN		
	17C418: € 7.240,00	17E912: € 7.900,00
	17C421: € 7.240,00	17E913: € 7.900,00
	17C320: € 7.555,00	
BROCHURE		
	320599	320599

* Sleutel 111733, 118 ml TSL™ 238049



SPECIFICATIES & PRIJZEN



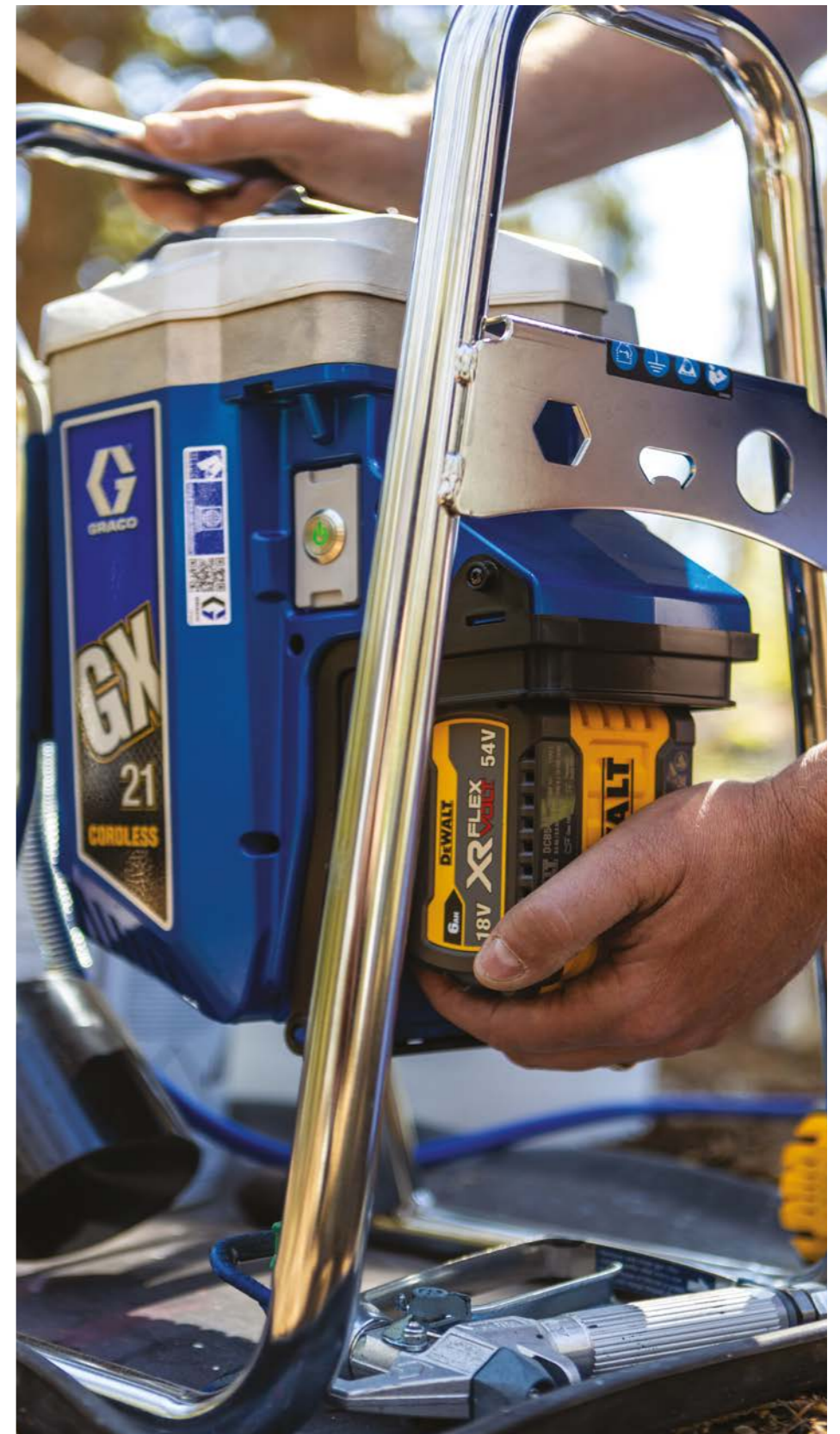

PROFESSIONEEL AIRLESS - 1

	GX™				
	19	FF	FF Cordless	21	21 Cordless
					
TECHNISCHE GEGEVENS					
Artikelnummers: EU - 230V	18H284	17G184	25U466	17G183	25T967
Artikelnummers: IT, DK, CH, UK - 230V		17H222		17H218	
Artikelnummer: Enkel UK - 230V	18H285		25U570		25T973
Max. tipgrootte: 1 pistool	0.019"	0.019"	0.019"	0.021"	0.021"
Max. debiet - l/min. (gpm)	1.5 (0.38)	1.5 (0.38)	1.5 (0.38)	1.8 (0.47)	1.8 (0.47)
Max. druk - bar (PSI)	207 (3000)	207 (3000)	207 (3000)	207 (3000)	207 (3000)
Gewicht - kg (lbs)	11.3 (25)	14.1 (31)	15.9 (35)	13.2 (29)	14.1 (31)
KENMERKEN					
Chassis	Directe Aanzuiging	Met materiaaltrechter	Met materiaaltrechter	Direkte aanzuiging	Direkte aanzuiging
Aanzuigstelsysteem	Aanzuigslang	Materiaaltrechter van 5.7 L	Materiaaltrechter van 5.7 L	Aanzuigslang	Aanzuigslang
Bal klopper - PushPrime™	■	■	■	■	■
Geschikt voor solventen		■	■	■	■
Hydraulische manometer		■	■	■	■
ProXChange™ Pomsysteem	■	■	■	■	■
SAMENSTELLING					
Tips	LP517	FFLP210	FFLP210	LP517 + FFLP310	LP517 + FFLP310
Tiphouder		RAC X™ - 246215			RAC X™ - 246215
Pistoolfilter (maasgrootte)	Easy-Out™ 50 - 218131	Easy Out™ 100 - 287033	Easy Out™ Compact 100 - 19Y356	Easy Out™ 50 - 218131	Easy Out™ 50 - 218131
Pistool	SG3, 4-vingers - 17J910	FTx™-E, 2-vingers - 17J261	Contractor™ PC Compact - 19Y350	SG3™, 4-vingers - 17J910	SG3™, 4-vingers - 17J910
Pompfilter (maasgrootte)	40 - 257094			40 - 257094	40 - 257094
Slang	DuraFlex™ 1/4" x 15m - 247340	Blue Max™ II 3/16" x 7.5m - 214698	Blue Max™ II 3/16" x 7.5m - 214698	DuraFlex™ 1/4" x 15m - 247340	DuraFlex™ 1/4" x 15m - 247340
Stroomvoorziening	2m stroomkabel	2m stroomkabel	2x 54V DeWalt® FlexVolt® 6.0 Ah accu's	2m stroomkabel	2x 54V DeWalt® FlexVolt® 6.0 Ah accu's
Batterijlader			DeWalt® ventilator-gekoelde snellader		DeWalt® ventilator-gekoelde snellader
Gereedschap		Ingebouwd gereedschap voor pomp			Ingebouwd gereedschap voor pomp
PRIJZEN					
	18H284: € 1.255,00	17G184: € 1.615,00	25U466: € 2.200,00	17G183: € 1.480,00	25T967: € 1.955,00
		17H222: € 1.615,00		17H218: € 1.480,00	
	18H285: € 1.255,00		25U570: € 2.200,00		25T973: € 1.955,00
BROCHURE	300735				



SPECIFICATIES & PRIJZEN

PROFESSIONEEL AIRLESS - 2





	CLASSIC				CLASSIC
	390 PC Stand	390 PC Cordless	390 PC Hi Boy	S 395 PC Stand	S 495 PC Hi Boy
					
TECHNISCHE GEGEVENS					
Artikelnummers: EU - 230V	17C348	25T863	17C349	17C361	17E025
Artikelnummers: IT, DK, CH - 230V	17C346		17C351	-	17E026
Artikelnummers: UK - 110V	17C347		-	17C359	-
Artikelnummer: Enkel UK - 230V		25T943			
Max. tipgrootte: 1 pistool					
Max. debiet - l/min (gpm)					
Max. druk - bar (PSI)	227 (3300)	227 (3300)	227 (3300)	227 (3300)	227 (3300)
Motortype - kW (pk)	0.46 (0.625) DC	0.46 (0.625) DC zonder koolstofborstel	0.46 (0.625) DC	0.65 (0.875) TEFC DC	0.74 (1.0) TEFC DC
Gewicht - kg (lbs)	14 (30)	15 (33)	31 (69)	19 (42)	33 (73)
KENMERKEN					
SmartControl™				1.0	1.0
Hydraulische manometer	■	■	■	■	■
FastFlush™					
ProGuard					
Endurance™ pomp	■	■	■	■	■
ProConnect™	■	■	■	■	■
TiltBack™			■	■	■
Slanghouder			■	■	■
Gereedschapskist			■	■	■
SAMENSTELLING					
Tips	LP517				LP517
Tiphouder	RAC™ X - 246215				RAC™ X - 246215
Pistoolfilter (maasgrootte)	Easy Out™ 60 - 287032				Easy Out™ 60 - 287032
Pistool	FTx™-E, 4-vingers - 288438				FTx™-E, 4-vingers - 288438
Slang	Blue Max™ II 1/4" x 15m - 240794				Blue Max™ II 1/4" x 15m - 240794
Stroomvoorziening	3m stroomkabel	2x 54V DeWalt® FlexVolt 6.0 Ah accu's	3m stroomkabel	3m stroomkabel	3m stroomkabel
Batterijlader		DeWalt® ventilatorgekoelde snellader			
Gereedschap	■	■	■	■	■
PRIJZEN					
	17C348: € 3.310,00	25T863: € 3.915,00	17C349: € 3.560,00	17C361: € 3.840,00	17E025: € 4.485,00
	17C346: € 3.310,00		17C351: € 3.560,00		17E026: € 4.485,00
	17C347: € 3.180,00	25T943: € 3.915,00		17C359: € 3.585,00	
BROCHURE	300733	300733	300733	300733	300733

* Pistoolgereedschap 15F446, sleutel 111733, 118 ml TSL™ 238049



SPECIFICATIES & PRIJZEN

PROFESSIELE AIRLESS - 3

	ULTRA XT™			
	490 XT Stand	490 XT Hi Boy	495 XT Stand	495 XT Hi Boy
				
TECHNISCHE GEGEVENS				
Artikelnummers: EU - 230V	19D525	19D526	19D527	19D528
Artikelnummers: UK - 110V	-	-	19D529	19D530
Max. tipgrootte: 1 pistool	0.025"	0.025"	0.027"	0.027"
Max. debiet - l/min (gpm)	2.6 (0.68)	2.6 (0.68)	3.0 (0.79)	3.0 (0.79)
Max. druk - bar (PSI)	227 (3300)	227 (3300)	227 (3300)	227 (3300)
Motortype - kW (pk)	Xtreme Torque - 0.79 (1.3)	Xtreme Torque - 0.79 (1.3)	Xtreme Torque - 1.26 (1.7)	Xtreme Torque - 1.26 (1.7)
Gewicht - kg (lbs)	14 (30)	30 (66)	14 (30)	30 (66)
KENMERKEN				
NIEUW LED Display	■	■	■	■
NIEUW Zuigerpomp	Endurance Vortex	Endurance Vortex	Endurance Vortex	Endurance Vortex
NIEUW Vortex-Zuigerstand	Chromex	Chromex	Chromex	Chromex
NIEUW Rapid-Response Drukregelaar	■	■	■	■
NIEUW Selecteerbare Prestatiemodi	■	■	■	■
NIEUW TurboClean	■	■	■	■
ProConnect	■	■	■	■
WatchDog	■	■	■	■
ProGuard	■	■	■	■
Gereedschapskist		Optioneel - 287253		Optioneel - 287253
TiltBack		■		■
Slanghouder		■		■
SAMENSTELLING				
Tips	LP517			
Tiphouder	RAC X – 246215			
Pistoolfilter (maatgrootte)	Easy-Out 60 – 287032			
Pistool	Contractor PC – 17Y043			
Slang	BlueMax™ II 1/4" x 15m - 240794			
Gereedschap	■*	■*	■*	■*
PRIJZEN				
	19D525: € 5.030,00	19D526: € 5.295,00	19D527: € 5.360,00	19D528: € 5.750,00
			19D529: € 5.070,00	19D530: € 5.460,00
BROCHURE	3J0616	3J0616	3J0616	3J0616



SPECIFICATIES & PRIJZEN

PROFESSIONEEL AIRLESS - 5

ULTRA® XT™ STANDARD

695 XT

795 XT

1095 XT



ULTRA® XT™ PROCONTRACTOR

695 XT

795 XT





1095 XT



TECHNISCHE GEGEVENS	ULTRA® XT™ STANDARD			ULTRA® XT™ PROCONTRACTOR		
	695 XT	795 XT	1095 XT	695 XT	795 XT	1095 XT
Artikelnummers: EU - 230V	19F727	19F731	19F735	19F729	19F733	19F736
Artikelnummers: IT, DK, CH - 230V	-	-	-	20B951	20B953	20B955
Artikelnummers: UK - 110V	19F728	19F732	-	19F730	19F734	-
Max. Tipgrootte: 1 pistool	0.031"	0.033"	0.035"	0.031"	0.033"	0.035"
Max. Tipgrootte: 2 pistolen	0.023"	0.025"	0.027"	0.023"	0.025"	0.027"
Max. Debiet - l/min (gpm)	4.0 (1.05)	4.5 (1.2)	4.9 (1.3)	4.0 (1.05)	4.5 (1.2)	4.9 (1.3)
Max. Druk - bar (PSI)	227 (3300)	227 (3300)	227 (3300)	227 (3300)	227 (3300)	227 (3300)
Motortype - kW (pk)	Xtreme Torque - 1.6 (2.1)	Xtreme Torque -1.7 (2.3)	Xtreme Torque - 2.0 (2.7)	Xtreme Torque - 1.6 (2.1)	Xtreme Torque -1.7 (2.3)	Xtreme Torque - 2.0 (2.7)
Gewicht - kg (lbs)	42 (93)	42 (93)	51 (112)	51 (112)	51 (112)	59 (129)
KENMERKEN						
Pomp	Endurance Vortex	Endurance Vortex	Endurance Vortex	Endurance Vortex	Endurance Vortex	Endurance Vortex
Zuigerstang	Chromex	Chromex	Chromex	MaxLife	MaxLife	MaxLife Extreme
Pompcylinder	Hardchrom	Hardchrom	Hardchrom	MaxLife	MaxLife	MaxLife
LED-display	■	■	■			
NIEUW Rapid-Response Drukregelaar	■	■	■	■	■	■
NIEUW Selecteerbare Prestatiemodi	■	■	■	■	■	■
NIEUW TurboClean	■	■	■	■	■	■
NIEUW SmartDisplay XT		Optioneel - 20B432		■	■	■
NIEUW Contractor PowerShot XT™ aansluitklaar		Optioneel - 20B432		■	■	■
BlueLink		Optioneel - 20B432		■	■	■
ProGuard	■	■	■	■	■	■
Watchdog	■	■	■	■	■	■
ProConnect	■	■	■	■	■	■
Grove filter		Standard			Versterkt	
Toolbox		Optioneel - 287253		■	■	■
TiltBack	■	■	■	■	■	■
QuickReel		Optioneel - 25V145		■	■	■
Lekbestendige banden	Optioneel - 20B198 (x2)	Optioneel - 20B198 (x2)	Optioneel - 17E687 (x2)	■	■	■
SAMENSTELLING						
Tips		LP517			LP517	
TIPHOUDER		RAC X - 246215			RAC X - 246215	
Pistool		Contractor PC - 17Y043			Contractor PC - 17Y043	
Pistoolfilter (maasgrootte)		Easy-Out 60 - 287032			Easy-Out 60 - 287032	
Slang		BlueMax™ II 1/4" x 15m - 240794			BlueMax™ II 1/4" x 15m - 240794	
Hulp slang						
Gereedschap		■*			■*	
PRIJZEN						
	19F727: € 7.845,00	19F731: € 8.425,00	19F735: € 9.005,00	19F729: € 9.010,00	19F733: € 9.610,00	19F736: € 10.195,00
				20B951: € 9.010,00	20B953: € 9.610,00	20B955: € 10.195,00
	19F728: € 6.955,00	19F732: € 7.875,00		19F730: € 7.750,00	19F734: € 8.690,00	
BROCHURE		3J0616			3J0616	

SPECIFICATIES & PRIJZEN

TEXTUUR - 1

	MARK HD 3-IN-1 STANDARD			MARK HD 3-IN-1 PROCONTRACTOR MARK X HD
	MARK V HD	MARK VII HD	MARK X HD	
				
TECHNISCHE GEGEVENS				
Artikelnummers: EU - 230V	17E655	17E665	17E669	17E671
Artikelnummers: IT, DK, CH - 230V	-	-	-	17E672
Artikelnummers: UK - 110V	17E659	-	-	-
Max. tipgrootte - 230V	Verf 0.035" Pleister 0.037"	Verf 0.041" Pleister 0.047"	Verf 0.045" Pleister 0.051"	Verf 0.045" Pleister 0.051"
Max. tipgrootte - 110V	Verf 0.039" Pleister 0.041"			
Max. debiet - l/min (gpm)* - 230V	4.3 (1.2)	6.0 (1.6)	8.3 (2.2)	8.3 (2.2)
Max. debiet - l/min (gpm)* - 110V	5.1 (1.35)			
Max. druk - bar (PSI)	227 (3300)	227 (3300)	227 (3300)	227 (3300)
Motortype - kW - (HP) - 230V	1.65 (2.2)	1.9 (2.5)	3.0 (4.0)	3.0 (4.0)
Motortype - kW - (HP) - 110V	2.0 (2.8)			
Gewicht - kg (lbs)	57 (125)	60 (132)	68 (150)	79 (174)
KENMERKEN				
BlueLink™	■	■	■	■
SmartControl™ met ProGuard™	4.0	4.0	4.0	4.0
LED Display				■
Hydraulische manometer	■	■	■	■
FastFlush™	■	■	■	■
Watchdog™	■	■	■	■
Endurance™ Pomp	■	■	■	Endurance™ Vortex
ProConnect™				2.0
Zuigerstang	Hardchrom	Hardchrom	Hardchrom	MaxLife™
Pompcilinder	Hardchrom	Hardchrom	Hardchrom	MaxLife™
MaxFlo 2	■	■	■	■
Grove filter	Standaard	Standaard	Standaard	Versterkt
TiltBack™	■	■	■	■
QuickReel™				■
Lekbestendige banden				
SAMENSTELLING				
Tips	HDA427 + HDA531	HDA531 + 541		HDA531 + 541
Tiphouder	RAC X™ - 246215			RAC X™ - 246215
Pistool	HD Blue Texture - 289605		HD Inline Texture - 245820	HD Inline Texture - 245820
Slang	Blue Max™ II 3/8" x 15m - 240797	Blue Max™ II 1/2" x 15m - 278499		Blue Max™ II 1/2" x 15m - 278499
Hulp slang	Blue Max™ II 1/4" x 0.9m - 277249	Blue Max™ II 3/8" x 3.5m - 191239		Blue Max™ II 3/8" x 3.5m - 191239
Gereedschap		■**		■**
PRIJZEN				
	17E655: € 10.335,00	17E665: € 11.250,00	17E669: € 12.760,00	17E671 € 13.910,00
	17E659: € 9.765,00			17E672 € 13.910,00
BROCHURE	300716	300716	300716	300716



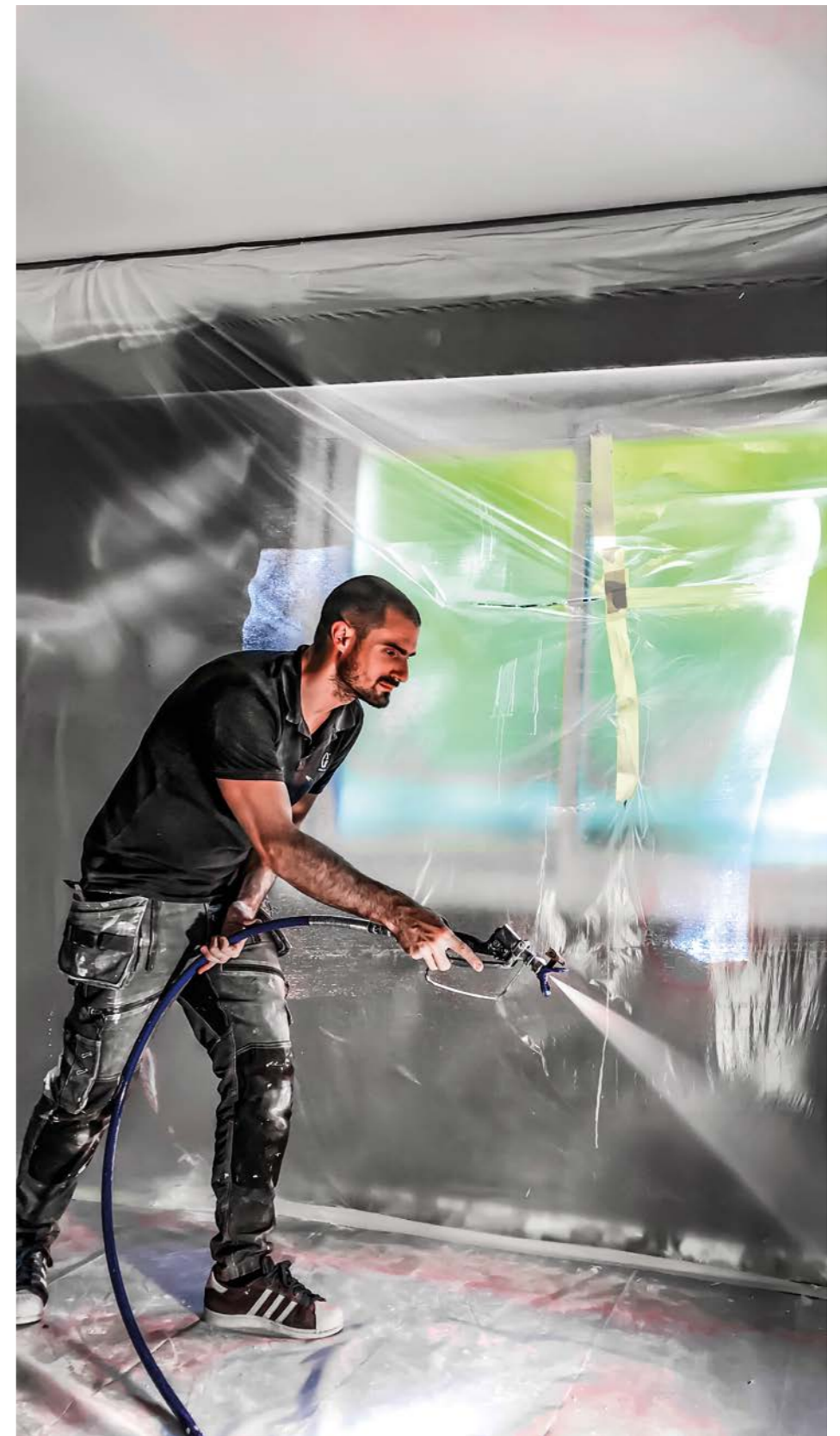

* Debiet sterk afhankelijk van het soort pleistermateriaal. Kleinere ID keramische kogels laten hoger debiet toe bij pleistermateriaal dan SST kogels bij verf.

** Pistoolgereedschap 15F446, sleutel 111733, 118 ml TSL™ 238049



SPECIFICATIES & PRIJZEN

TEXTUUR - 2





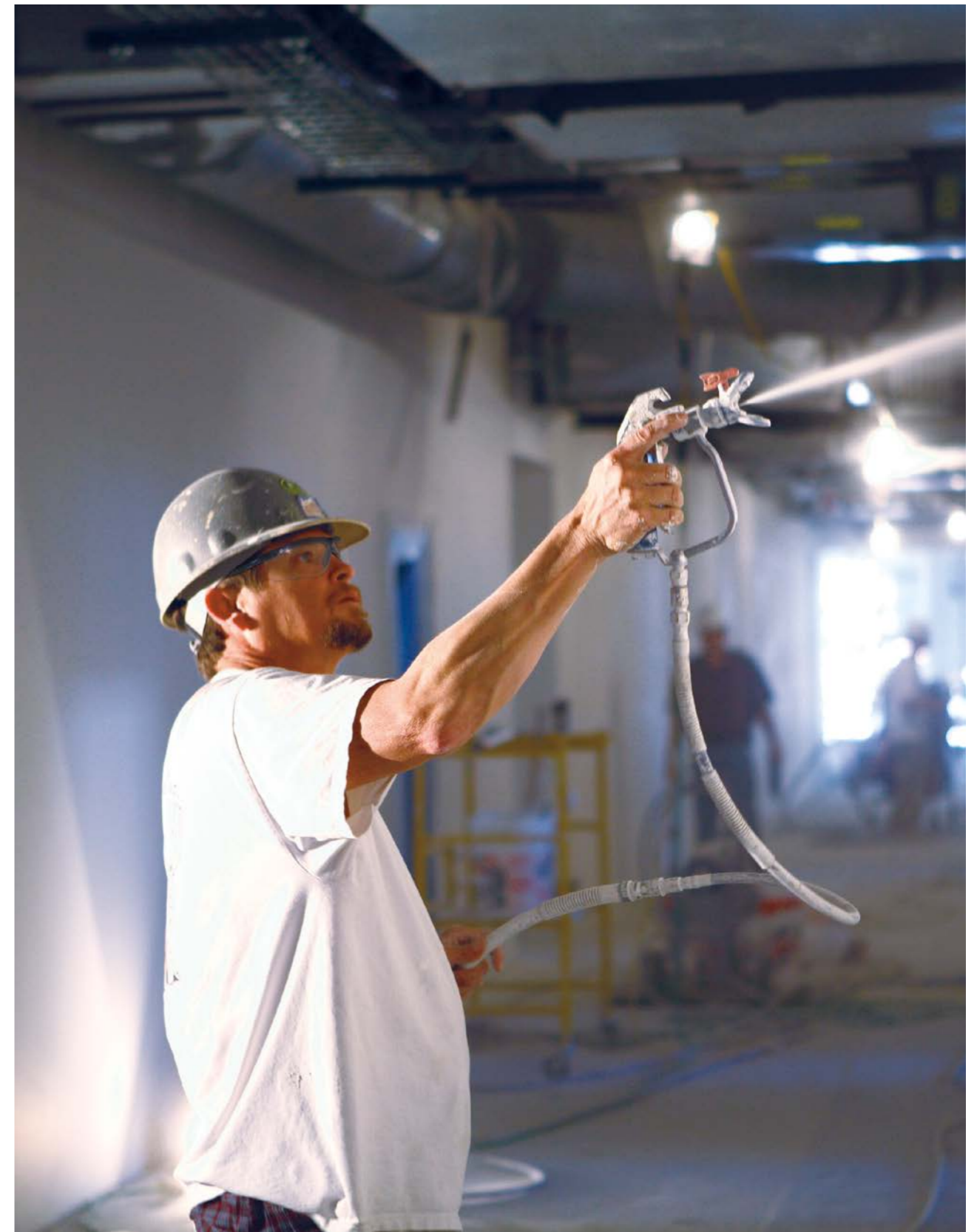

	MARK XT™ HD 3-IN-1 STANDARD		MARK XT™ HD 3-IN-1 PROCONTRACTOR	
	MARK V XT	MARK VII XT	MARK V XT	MARK VII XT
				
TECHNISCHE GEGEVENS				
Artikelnummers: EU - 230V	19F739	19F743	19F741	19F744
Artikelnummers: IT, DK, CH - 230V	-	-	20B959	20B961
Artikelnummers: UK - 110V	19F740	-	19F742	-
Max. Tipgrootte - 230V	Verf 0.035" Pleister 0.037"	Verf 0.041" Pleister 0.047"	Verf 0.035" Pleister 0.037"	Verf 0.041" Pleister 0.047"
Max. Tipgrootte - 110V	Verf 0.039" Pleister 0.041"		Verf 0.039" Pleister 0.041"	
Max. Debiet - l/min (gpm) ° - 230V	4.6 (1.2)	6.4 (1.7)	4.6 (1.2)	6.4 (1.7)
Max. Debiet - l/min (gpm) ° - 110V	5.6 (1.5)		5.6 (1.5)	
Max. Druk - bar (PSI)	227 (3300)	227 (3300)	227 (3300)	227 (3300)
Motortype - kW - (pk) - 230V	Xtreme Torque - 1.7 (2.3)	Xtreme Torque - 2.1 (2.9)	Xtreme Torque - 1.7 (2.3)	Xtreme Torque - 2.1 (2.9)
Motortype - kW - (pk) - 110V	Xtreme Torque - 2.1 (2.9)		Xtreme Torque - 2.1 (2.9)	
Gewicht - kg (lbs)	55 (122)	57 (126)	64 (140)	67 (147)
KENMERKEN				
Pomp	Endurance Vortex	Endurance Vortex	Endurance Vortex	Endurance Vortex
Zuigerstang	Chromex	Chromex	MaxLife Extreme	MaxLife Extreme
Pompcylinder	Hardchrom	Hardchrom	MaxLife	MaxLife
LED-display	■	■	■	■
NIEUW Rapid-Response Drukregelaar	■	■	■	■
NIEUW Selecteerbare Prestatiemodi	■	■	■	■
NIEUW TurboClean	■	■	■	■
NIEUW SmartDisplay XT	Optioneel - 20B432		■	■
BlueLink	Optioneel - 20B432		■	■
ProGuard	■	■	■	■
Watchdog	■	■	■	■
ProConnect	■	■	■	■
Grove filter	Standard	Standard	Versterkt	Versterkt
Toolbox	Optioneel - 287253		■	■
TiltBack	■	■	■	■
QuickReel	Optioneel - 25V145	Optioneel - 25V146	■	■
Lekbestendige banden	Optioneel- 17E687 (x2)		■	■
SAMENSTELLING				
Tips	HDA427 + HDA531		HDA531 + HDA541	
Tiphouder	RAC X - 246215		RAC X - 246215	
Pistool	HD Blue Texture - 289605		HD Blue Texture - 289605	
Slang	BlueMax™ II 3/8" x 15m - 240797		BlueMax™ II 1/2" x 15m - 278499	
Hulp slang	BlueMax™ II 1/4" x 0.9m - 277249		BlueMax™ II 3/8" x 3.5m - 191239	
Gereedschap	■*		■*	
PRIJZEN				
	19F739: € 10.955,00	19F743: € 11.925,00	19F741: € 12.175,00	19F744: € 13.145,00
			20B959: € 12.175,00	20B961: € 13.145,00
	19F740: € 10.350,00		19F742: € 11.570,00	
BROCHURE	3J0626		3J0626	

* Debiet sterk afhankelijk van het soort pleistermateriaal. Kleinere ID keramische kogels laten hoger debiet toe bij pleistermateriaal dan SST kogels bij verf.





SPECIFICATIES & PRIJZEN

TEXTUUR - 3

	T-MAX™ AIRLESS			T-MAX™ AIR-ASSISTED		T-MAX™ AIRLESS/AIR ASSISTED	
	506	657	6912	6912	6912	6912	6912
							
TECHNISCHE GEGEVENS							
Artikelnummers: EU - 230V	17X980	17X983	17X986	17X990	17X993	17Z285	17Z288
Artikelnummers: IT, DK, CH - 230V	17X981	17X984	17X987	17X991	17X994	17Z286	17Z289
Artikelnummers: UK - 110V	17X982	17X985	17X988	17X992	17Z282	17Z287	17Z290
Max. Tipgrootte	Pleister 0.051"	Pleister 0.061"	Pleister 0.071"	Pleister 0.071"	Pleister 0.071"	Pleister 0.071"	Pleister 0.071"
Max. debiet - l/min (gpm) - 230V	6.4 (1.7)	7.2 (1.9)	12 (3.17)	12 (3.17)	12 (3.17)	12 (3.17)	12 (3.17)
Max. druk - bar (PSI)	50 (730)	65 (940)	69 (1000)	69 (1000)	69 (1000)	69 (1000)	69 (1000)
Motortype - kW (pk)	0.9 (1.2)	0.9 (1.2)	2 (2.8)	2 (2.8)	2 (2.8)	2 (2.8)	2 (2.8)
Kompressor l/min	Externe compressor			Externe compressor		Externe compressor	
Gewicht - kg (lbs)	71 (156)	73 (160)	86 (190)	86 (190)	86 (190)	86 (190)	86 (190)
KENMERKEN							
SmartControl™	■	■	■	■	■	■	■
LED Display			■	■	■	■	■
Controle Debiet / Druk	Geïntegreerd	Geïntegreerd	■	■	■	■	■
Pomp afschakelbaar aan pistool			Optioneel	Schakelaar op afstand	Ingebouwd in STX™pistool	Schakelaar op afstand	Ingebouwd in STX™pistool
Materiaalrechtter	4 zakken	6 zakken	6 zakken	6 zakken	6 zakken	6 zakken	6 zakken
Endurance™ Pomp	■	■	■	■	■	■	■
Zuigerstang pakking	Single Packing	Single Packing	V-Packing	V-Packing	V-Packing	V-Packing	V-Packing
Modular Split Frame	■	■	■	■	■	■	■
Zakkenpers	Optioneel	Optioneel	Optioneel	Optioneel	Optioneel	Optioneel	Optioneel
Vibra-Flo™ haker	Optioneel	Optioneel	Optioneel	Optioneel	Optioneel	Optioneel	Optioneel
SAMENSTELLING							
Tips	HDA651	HDA651 + HDA655	HDA651 + HDA655			HDA651 + HDA655	HDA651 + HDA655
Wide Tex Tips				W4H, W6H, W8H, W10H, W12H, WXLH		W4H, W6H, W8H, W10H, W12H, WXLH	
Tips				4mm, 6mm, 8mm, 10mm	4mm, 6mm, 8mm, 10mm, 12mm	4mm, 6mm, 8mm, 10mm	4mm, 6mm, 8mm, 10mm, 12mm
Tiphouder	RAC X™ - 246215					RAC X™ - 246215	
Pistool	T-Max™ Lance - 17Z054			FreeFlo™ - 17Z128	STX™ - 17Y910	T-Max™ Lance - 17Z054 FreeFlo™ - 17Z128	T-Max™ Lance - 17Z054 STX™ - 17Y910
Slang	1" x 5m - 289960	1" x 10m - 289961	1" x 5m - 289960 1" x 10m - 289961	1" x 5m - 289960 1" x 10m - 289961		1" x 5m - 289960 1" x 10m - 289961	
Hulp slang		3/4" x 3m - 289959		3/4" x 3m - 289959		3/4" x 3m - 289959	
Gereedschapskist	■			■		■	
Gereedschap	Schraper - 19A646			Schraper - 19A646		Schraper - 19A646	
PRIJZEN							
	17X980: € 8.550,00	17X983: € 9.820,00	17X986: € 11.735,00	17X990: € 12.695,00	17X993: € 13.245,00	17Z285: € 13.930,00	17Z288: € 14.435,00
	17X981: € 8.550,00	17X984: € 9.820,00	17X987: € 11.735,00	17X991: € 12.695,00	17X994: € 13.245,00	17Z286: € 13.930,00	17Z289: € 14.435,00
	17X982: € 8.550,00	17X985: € 9.820,00	17X988: € 11.735,00	17X992: € 12.695,00	17Z282: € 13.245,00	17Z287: € 13.930,00	17Z290: € 14.435,00
BROCHURE	320596	320596	320596	320596	320596	320596	320596





SPECIFICATIES & PRIJZEN

TEXTUUR - 4

	RTX™	
	5500 PI	5500 PX
		
TECHNISCHE GEGEVENS		
Artikelnummers: EU, IT, DK, CH, UK - 230V	17H577	17H580
Max. debiet - l/min (gpm)	21 (5.5)	21 (5.5)
Max. druk - bar (PSI)	7 (100)	7 (100)
Motortype - kW (pk)	1.5 (2.0) Borstelloos MaxPower™	
Kompressor l/min	257	257
Max. luchtdruk - bar (PSI)	3.5 (50)	3.5 (50)
Gewicht - kg (lbs)	74.4 (164)	78.9 (174)
KENMERKEN		
Pomp	RotoFlex™ II	RotoFlex™ II
Externe Air Kit		■
Materiaalrechter	57L	57L
Manometer	■	■
ProGuard™	■	■
COMPOSITION		
Wide Tex Tips	4mm, 6mm, 8mm, 10mm, 12mm	4mm, 6mm, 8mm, 10mm, 12mm (Gehard)
Tips	3mm, 4mm, 6mm, 8mm, 10mm, 12mm	
Pistool	Heavy-Duty-spuitpistool - 24S135	
Slang	Doorzichtig 1" x 7.5m - 17J420	Heavy Duty 1-1/4" x 7.5m - 17L005
Gereedschapskist	■	
PRIJZEN		
	17H577: € 8.925,00	17H580: € 9.670,00
BROCHURE	300661	300661



SPECIFICATIES & PRIJZEN

TEXTUUR - 4
COMPRESSOR-HOPPER

	FASTFINISH		G-TEX	FASTFINISH
	COMPRESSOR	STANDARD (PRO)	HOPPER GUN	HOPPER GUN
				
TECHNISCHE GEGEVENS				
Artikelnummers: EU, IT, DK, CH, UK - 230V	25D491	25D495 (Standard version) 25D493 (Pro version)	25D497	25D496
Kompressor l/min	255	255	-	-
Max. luchtdruk - bar (PSI)	Vooraf ingesteld 2,75 (40)	Vooraf ingesteld 2,75 (40)	-	-
Gewicht - kg (lbs)	33.5 (74)	35.18 (78.8)	1.85 (4.1)	2.18 (4.8)
KENMERKEN				
Pistool met materiaalhouder onder druk		enkel Pro versie		■
Materiaalrechter		7.5 L (Standard versie) 5.5L (Pro versie)	7.5L	5.5L
Druk/Debiet regeling		enkel Pro versie		■
Lekbestendige banden	■	■		
SAMENSTELLING				
Tips		4mm, 6mm, 8mm	4mm, 6mm, 8mm	4mm, 6mm, 8mm
Pistool		G-TEX Gravity-Fed - 25D497 (Standard version) FastFinish Pressure-Boosted - 25D496 (Pro version)	G-TEX Gravity-Fed - 25D497	FastFinish Pressure-Boosted - 25D496
Slang	3/8" x 15m - 17U302			
PRIJZEN				
	25D491: € 1.485,00	25D495: € 1.745,00 25D493: € 1.790,00	25D497: € 265,00	25D496: € 326,00
BROCHURE	300760	300760	300760	300760

SPECIFICATIES & PRIJZEN

TEXTUUR - 5



	APX	APX	
	5200	6200	8200
			
TECHNISCHE GEGEVENS			
Artikelnummers: EU - 230V	-	17N345 17N346	17N352 17N353
Artikelnummers: IT, DK, CH - 230V	-	17N343 17N344	17N350 17N351
Artikelnummers: UK - 110V	17S762 17V697	-	-
Max. tipgrootte	0.045"	0.051"	0.057"
Max. debiet - l/min (gpm)* - 110V	5.1 (1.35)	6.0 (1.6)	8.0 (2.1)
Max. druk - bar (PSI)	207 (3000)	207 (3000)	207 (3000)
Motortype - kW (pk)	1.86 (2.5) DC Zonder koolstofborstels	1.86 (2.5) DC Zonder koolstofborstels	3 (4) DC Zonder koolstofborstels
Gewicht - kg (lbs)	69 (151)	69 (151)	78 (170)
KENMERKEN			
ProGuard™	■	■	■
Endurance™ Pomp	Hardchrom	Hardchrom	Hardchrom
Digitale display	■	■	■
Materiaaltrechter	80L (6 zakken)	60L (4 zakken)	80L (6 zakken)
Zakkenpers		17N346 + 17N344	17N353 + 17N351
Vibra-Flo™ Shaker	-	■	■
ProConnect II	■	■	■
SAMENSTELLING			
Tips	HDA531	HDA641	
Tiphouder	RAC X™ - 246215	RAC X™ - 246215	
Pistool	HD Blue Texture - 289605 (17S762) HD Inline Texture 245820 (17V697)	HD Inline Texture - 245820	
Slang	Blue Max™ II 1/2" x 15m - 278499	X-Flo 5/8" x 15m - 17N984	
Hulp slang	Blue Max™ II 3/8" x 3.5M - 191239	Super-Flex™ 1/2" x 4.5m - 17N982	
Gereedschapskist	■	■	■
PRIJZEN			
		17N345: € 12.875,00	17N352: € 14.885,00
		17N346: € 13.905,00	17N353: € 15.915,00
		17N343: € 12.875,00	17N350: € 14.885,00
		17N344: € 13.905,00	17N351: € 15.915,00
	17S762: € 12.215,00		
	17V697: € 12.215,00		
BROCHURE			
	300743	300743	300743

* Debiet sterk afhankelijk van het soort pleistermateriaal. Kleinere ID keramische kogels laten hoger debiet toe bij pleistermateriaal dan SST kogels bij verf.



SPECIFICATIES & PRIJZEN

TEXTUUR - 6

	POWERFILL		
	3.5 STANDARD	3.5 PROCONTRACTOR	3.5 PROCONTRACTOR XL
			
TECHNISCHE GEGEVENS			
Artikelnummers: EU - 230V	26B435	26B436	26B437
Artikelnummers: UK - 230V	26B536	26B537	26B538
Max. Debiet - l/min (gpm)	13.2 (3.5)	13.2 (3.5)	13.2 (3.5)
Motor	DC zonder koolstofborstels	DC zonder koolstofborstels	DC zonder koolstofborstels
Gewicht - kg (lbs)	6.8 (15)	7.7 (17)	9.1 (20)
KENMERKEN			
SmartControl	■	Pro	Pro
Precisievuiltechnologie		■	■
Snelheidsschakelaar	ProControl™	ProControl™	ProControl™
Continue werking		■	■
PowerStroke-pomp	■	■	■
ProConnect	■	■	■
Gereedschapsloos ontwerp	■	■	■
Verstelbare stabilisatiepoot	■	■	■
Emmersteun	Verstelbaar tot 20L (18-38 cm bereik)	Verstelbaar tot 20L (18-38 cm bereik)	Verstelbaar tot 20L (18-38 cm bereik)
SAMENSTELLING			
Vuller*	Standaard horizontaal	Hi-Rise-vulbuis (35 cm)	
Aansluitingen	Flat box, Corner/Angle box, Nail Spotter, Samengestelde buis		
Inlaatfilter (mesh)	Gereedschapsloos 10 mesh		
Voeding	18V 2.0 Ah DEWALT® batterij*		
Batterijlader	■	■	■
PRIJZEN			
	26B435: € 1.560,00	26B436: € 1.740,00	26B437: € 1.855,00
	26B536: € 1.560,00	26B537: € 1.740,00	26B538: € 1.855,00
BROCHURE	300795	300795	300795

* DEWALT® en het DEWALT-logo zijn handelsmerken van DEWALT Industrial Tool Co. en worden onder licentie gebruikt.

** De zwanenhalsverbinding is een optionele accessoire.



SPECIFICATIES & PRIJZEN

HEAVY DUTY - 1

GMAX II (HD 3-IN-1) STANDARD

3900

5900
(5900 HD)7900
(7900 HD)

GMAX II (HD 3-IN-1) PROCONTRACTOR

3900

5900
(5900 HD)7900
(7900 HD)

GMAX II (HD 3-IN-1) IRONMAN

5900

7900
(7900 HD)

TECHNISCHE GEGEVENS	GMAX II (HD 3-IN-1) STANDARD			GMAX II (HD 3-IN-1) PROCONTRACTOR			GMAX II (HD 3-IN-1) IRONMAN	
	3900	5900 (5900 HD)	7900 (7900 HD)	3900	5900 (5900 HD)	7900 (7900 HD)	5900	7900 (7900 HD)
Artikelnummers	17G999	17H810 (17H819)	17H818 (17H820)	17E828	17E832 (17E840)	17E837 (17E842)	17E833	17E838 (17E843)
Max. tipgrootte: 1 pistool	0.036"	0.043"	0.047"	0.036"	0.043"	0.047"	0.043"	0.047"
Max. tipgrootte: 2 pistolen	0.023"	0.029"	0.035"	0.023"	0.029"	0.035"	0.029"	0.035"
Max. debiet - l/min (gpm)*	4.7 (1.25)	6.0 (1.6)	8.3 (2.2)	4.7 (1.25)	6.0 (1.6)	8.3 (2.2)	6.0 (1.6)	8.3 (2.2)
Max. druk - bar (PSI)	227 (3300)	227 (3300)	227 (3300)	227 (3300)	227 (3300)	227 (3300)	227 (3300)	227 (3300)
Cilinderinhoud motor - cm ³	120	200	200	120	200	200	200	200
Gewicht - kg (lbs)	50 (109)	64 (139)	67 (146)	57 (125)	70 (155)	74 (161)	64 (139)	67 (146)
KENMERKEN								
SmartControl™	3.0	3.0	3.0	3.0	3.0	3.0	3.0	3.0
LED Display	■	■	■	■	■	■	■	■
Hydraulische manometer	■	■	■	■	■	■	■	■
Endurance™ Pomp	■	■	■	Endurance™ Vortex	Endurance™ Vortex	Endurance™ Vortex	Endurance™ Vortex	Endurance™ Vortex
Pomp type	Verf	Verf (HD Pleister)	Verf (HD Pleister)	Verf	Verf (HD Pleister)	Verf (HD Pleister)		
ProConnect 2	■	■	■	■	■	■	■	■
Zuigerstang	Chromex	Chromex (Hard Chrom)	MaxLife™	MaxLife™	MaxLife™	MaxLife™	MaxLife Extreme™	MaxLife Extreme™
Pompcilinder	Hard Chrom	Hard Chrom	MaxLife™	MaxLife™	MaxLife™	MaxLife™	MaxLife™	MaxLife™
MaxFlo 2		■	■		■	■	■	■
Grove filter	Standard	Standard	Standard	Versterkt	Versterkt	Versterkt	Versterkt	Versterkt
TiltBack™	■	■	■	■	■	■	■	■
QuickReel™	■	■	■	■	■	■	■	■
Lekbestendige banden	■	■	■	■	■	■	■	■
SAMENSTELLING								
Tips	PAA517	PAA517 (LTX427, LTX531)		PAA517	PAA517 (LTX427, LTX531)		PAA517 (LTX427, LTX531)	
Tiphouder	RAC X™ - 246215			RAC X™ - 246215			RAC X™ - 246215	
Pistool	Contractor™ PC - 17Y043	Contractor™ PC - 17Y043 (HD Blue Texture - 289605)		Contractor™ PC - 17Y043	Contractor™ PC - 17Y043 (HD Blue Texture - 289605)		Contractor™ PC - 17Y043	Contractor™ PC - 17Y043 (HD Blue Texture - 289605)
Pistoolhouder (maasgrootte)	Easy Out™ 60 - 287032			Easy Out™ 60 - 287032			Easy Out™ 60 - 287032	
Slang	Blue Max™ II 1/4" x 15m - 240794	Blue Max™ II 1/4" x 15m - 240797 (3/8" x 15m - 289667)		Blue Max™ II 1/4" x 15m - 240794	Blue Max™ II 1/4" x 15m - 240797 (3/8" x 15m - 289667)		Blue Max™ II 1/4" x 15m - 240794	Blue Max™ II 1/4" x 15m - 240797 (3/8" x 15m - 289667)
Hulp slang		(Blue Max™ II 1/4" X 0.9 M - 241735)			(Blue Max™ II 1/4" X 0.9m - 241735)			(Blue Max™ II 1/4" X 0.9m - 241735)
Gereedschap		■**			■**			■**
PRIJZEN								
	17G999: € 9.250,00	17H810: € 11.665,00	17H818: € 13.005,00	17E828: € 10.320,00	17E832: € 12.740,00	17E837: € 14.075,00	17E833: € 12.740,00	17E838: € 14.075,00
		17H819: € 12.075,00	17H820: € 13.415,00		17E840: € 13.145,00	17E842: € 14.485,00		17E843: € 14.485,00
BROCHURE	300718	300718	300718	300719	300719	300719	300769	300769

* Debiet sterk afhankelijk van het soort pleistermateriaal. Kleinere ID keramische kogels laten hoger debiet toe bij pleistermateriaal dan SST kogels bij verf.

** 118 ml TSL™ 238049

SPECIFICATIES & PRIJZEN

HEAVY DUTY - 2









TECHNISCHE GEGEVENS				
Artikelnummers	24W941	24W943	24W965	24W967
Max. tipgrootte: 1 pistool	Verf 0.039" Pleistermateriaal 0.047"	Verf 0.053" Pleistermateriaal 0.057"	Verf 0.057" Pleistermateriaal 0.063"	Verf 0.057" Pleistermateriaal 0.063"
Max. debiet - l/min (gpm)*	5.9 (1.56)	8.9 (2.35)	11.3 (3.0)	11.3 (3.0)
Max. druk - bar (PSI)	227 (3300)	227 (3300)	227 (3300)	227 (3300)
Motor	Elektrisch 230V	Benzine	Elektrisch 380V	Benzine
Motortype - kW (pk)	2.2 (3)		5.5 (7.5)	
Cilinderinhoud motor - cm ³		200		270
Gewicht - kg (lbs)	89 (197)	90 (199)	107 (236)	99 (218)
KENMERKEN				
SmartControl™			Fase indicatie	
Endurance™ pomp	■	■	■	■
Hydraulisch aangedreven pomp	■	■	■	■
QuikReel™				
Slanghouder	■	■	■	■
MaxLife™				
Verwisselbaar (elektrisch-gas)	■	■	■	■
ProConnect™				
SAMENSTELLING				
Tips	HDA427 + HDA531		HDA643 + WA1239	
Tiphouder	RAC X™ - 246215			
Pistool	HD Blue Texture - 289605		HD Inline Texture - 245820	
Slang	Blue Max™ II 3/8" x 15m - 240797		Blue Max™ II 1/2" x 15m - 278499	
Hulp slang	Blue Max™ II 1/4" x 0.9m - 241735		Blue Max™ II 3/8" x 3.5m - 191239	
Gereedschap	■**			
PRIJZEN				
	24W941: € 14.085,00	24W943: € 14.745,00	24W965: € 15.155,00	24W967: € 15.155,00
BROCHURE				
	300722	300722	300722	300722

Artikelnummers	24W942	24W962	24W966	24W968	25D224	25D223
Max. tipgrootte: 1 pistool	Verf 0.039" Pleistermateriaal 0.047"	Verf 0.053" Pleistermateriaal 0.057"	Verf 0.057" Pleistermateriaal 0.063"	Verf 0.057" Pleistermateriaal 0.063"	0.041"	0.041"
Max. debiet - l/min (gpm)*	5.9 (1.56)	8.9 (2.35)	11.3 (3.0)	11.3 (3.0)	5.7 (1.5)	5.7 (1.5)
Max. druk - bar (PSI)	227 (3300)	227 (3300)	227 (3300)	227 (3300)	465 (6750)	465 (6750)
Motor	Elektrisch 230V	Benzine	Elektrisch 380V	Benzine	Elektrisch 380V	Benzine
Motortype - kW (pk)	2.2 (3)		5.5 (7.5)		5.5 (7.5)	
Cilinderinhoud motor - cm ³		200		270		270
Gewicht - kg (lbs)	103 (227)	104 (229)	120 (266)	112 (248)	107 (236)	99 (218)
KENMERKEN						
SmartControl™			Fase indicatie		Fase indicatie	
Endurance™ pomp	■	■	■	■	■	■
Hydraulisch aangedreven pomp	■	■	■	■	■	■
QuikReel™						
Slanghouder					■	■
MaxLife™						
Verwisselbaar (elektrisch-gas)	■	■	■	■	■	■
ProConnect™	■	■	■	■		
SAMENSTELLING						
Tips	HDA427 + HDA531		HDA643 + WA1239		XHD527 + XHD531	XHD527 + XHD531
Tiphouder	RAC X™ - 246215					
Pistool	HD Blue Texture - 289605		HD Inline Texture - 245820		XTR7 HF - XTR706	XTR7 HF - XTR706
Slang	2 x Blue Max™ II 3/8" x 15m - 240797		2 x Blue Max™ II 1/2" x 15m - 278499		1/2" x 15m - H75050	1/2" x 15m - H75050
Hulp slang	Blue Max™ II 1/4" x 0.9m - 241735		Blue Max™ II 3/8" x 3.5m - 191239		3/8" x 3m - H73810	3/8" x 3m - H73810
Gereedschap	■**					
PRIJZEN						
	24W942: € 15.155,00	24W962: € 15.820,00	24W966: € 16.225,00	24W968: € 16.225,00	25D224: € 16.365,00	25D223: € 16.365,00
BROCHURE						
	300723	300723	300723	300723	300758	300758

* Debiet sterk afhankelijk van het soort pleistermateriaal. Kleinere ID keramische kogels laten hoger debiet toe bij pleistermateriaal dan SST kogels bij verf.
 ** 118 ml TSL™ 238049

SPECIFICATIES & PRIJZEN

HEAVY DUTY - 3

	GH™ BIG RIG				GH™ BIG RIG	
	1017	2570	733	833	5040	933
						
TECHNISCHE GEGEVENS						
Artikelnummers: naakte versie	-	-	-	253471	-	16U281
Artikelnummers: naakte versie elektrische starter	16U277	16U278	16U279	16V258	16U280	16U285
Artikelnummers: OEM kit	-	24U325	-	253473	-	-
Max. tiprootte	-	-	0.065"	0.065"	0.067"	0.053"
Max. debiet - l/min (gpm)	62.5 (16.5)	26.5 (7.0)	15.1 (4.0)	15.1 (4.0)	13.2 (3.5)	9.5 (2.5)
Max. druk - bar (PSI)	70 (1000)	172 (2500)	276 (4000)	276 (4000)	345 (5000)	500 (7250)
Cilinderinhoud motor - cm ³	390	390	390	390	390	390
Elektrische starter	Ja	Ja	Ja	Enkel 16V258	Ja	Enkel 16U285
Gewicht - kg (lbs)	215 (473)	16U278 - 214 (471) 24U325 - 62 (136)	197 (434)	253471 - 163 (360) 16V258 - 181 (398) 253473 - 29 (63)	199 (438)	16U281 - 181 (398) 16U285 - 199 (438)
KENMERKEN						
Pomp type	Xtreme Piston QuikChange™	Xtreme Piston QuikChange™	Xtreme Piston QuikChange™	Endurance Pomp	Xtreme Piston QuikChange™	Xtreme Piston QuikChange™
Hydraulisch aangedreven pomp	■	■	■	■	■	■
Pompcilinder	Hardchrom	Hardchrom	Hardchrom	MaxLife™	Hardchrom	Hardchrom
Zuigerstang	Hardchrom	Hardchrom	Chromex	MaxLife™	Hardchrom	Chromex
Pakking	XtremeSeal/Leder	PTFE/Leder	XtremeSeal/Leder	V-Max Blue™	XtremeSeal/Leder	XtremeSeal/Leder
Trekstang	Zilver - 16U336	Goud - 16U339	Zilver - 16U336	-	Zilver - 16U336	Zilver - 16U336
Filter	Nee	Nee	Nee	Easy-Out™	Neen	Ja
Pulsatiedemper	Ja	Nee	Nee	Nee	Neen	Neen
Aanzuigset - 200 liter	2.0" ID PVC	2.0" ID PVC	1.25" ID Nylon	1.5" ID PVC	2.0" ID PVC	1.0" ID Nylon
Slanghouder	■	■	■	■	■	■
SAMENSTELLING						
	Naakte machines. Contacteer Graco voor machine configuraties.			Naakte machines. Contacteer Graco voor machine configuraties.		
PRIJZEN						
				253471: € 20.410,00		16U281: € 20.410,00
	16U277: € 28.030,00	16U278: € 26.165,00	16U279: € 22.650,00	16V258: € 22.650,00	16U280: € 22.650,00	16U285: € 22.645,00
		24U325: € 12.230,00		253473: € 11.110,00		
BROCHURE	320593	320593	320593	320593	320593	320593

SPECIFICATIES & PRIJZEN

PROFESSIONELE REINIGING - 1

G-FORCE™ II
3325 HA-DD 3230 HA-DD



G-FORCE™ II
4040 HG-DD 4040 HC-DD



G-FORCE™ II
4040 HG-BD 4040 HC-BD



TECHNISCHE GEGEVENS	G-FORCE™ II		G-FORCE™ II		G-FORCE™ II	
	3325 HA-DD	3230 HA-DD	4040 HG-DD	4040 HC-DD	4040 HG-BD	4040 HC-BD
Artikelnummers	25N638	25N639	25N681	25N682	25N683	25N684
Max. druk - bar (PSI)	227 (3300)	220 (3200)	275 (4000)	275 (4000)	275 (4000)	275 (4000)
Max. debiet - l/min (gpm)	9.46 (2.5)	11.36 (3)	15.14 (4)	15.14 (4)	15.14 (4)	15.14 (4)
Cilinderinhoud motor - cm³	200	270	390	390	390	390
Pomp	AR Messing Triplex	AR Messing Triplex	GP Messing Triplex	CAT Messing Triplex	GP Messing Triplex	CAT Messing Triplex
Gewicht - kg (lbs)	30.4 (67)	37.2 (82)	58.5 (129)	60.3 (133)	72.1 (159)	71.6 (158)
KENMERKEN						
Gardena® aansluiting	■	■	■	■	■	■
Chemische injectie kit	Geïntegreerd	Geïntegreerd	■	■	■	■
Directe aandrijving	■	■	■	■	■	■
Riemaandrijving					■	■
Aanpasbaar lossysteem	Geïntegreerd	Geïntegreerd	Extern	Extern	Extern	Extern
EZ Start-drukontlasting	■	■	■	■	■	■
Lichtgewicht aluminium frame	■	■	■	■	■	■
Thermische-sensor	■	■	■	■	■	■
Koud water	■	■	■	■	■	■
SAMENSTELLING						
Tips	0° - 805591 15° - 805592 25° - 805593 Chemicaliën tip - 805634	0° - 805539 15° - 805540 25° - 805541 Chemicaliën tip - 805634	0° - 805543 15° - 805544 25° - 805545 40° - 805546 Chemicaliën tip - 805634		0° - 805543 15° - 805544 25° - 805545 40° - 805546 Chemicaliën tip - 805634	
Pistool	91cm + QDs - 244784		91cm + QDs - 244784		91cm + QDs - 244784	
Filter (maasgrootte)	50		50		50	
Slang	15m + QDs - 244783		15m + QDs - 244783		15m + QDs - 244783	
Motorolie	■		■		■	
PRIJZEN						
	25N638: € 3.070,00	25N639: € 3.745,00	25N681: € 4.550,00	25N682: € 5.085,00	25N683: € 5.620,00	25N684: € 6.160,00
BROCHURE	320582	320582	320582	320582	320582	320582

SPECIFICATIES & PRIJZEN

WEGMARKERING - 1



	ES 500 Stencil	LINELAZER™ ES 500	LINELAZER™ ES 1000	LINELAZER™ V ES 2000
TECHNISCHE GEGEVENS				
Artikelnummer - 1 pistool	25U514	25U547	25U675	25U681
Artikelnummer - 2 pistolen	-	-	-	25U685
Max. spuittipformaat - 1 pistool	0.021"	0.021"	0.025"	0.033"
Max. spuittipformaat - 2 pistolen	-	-	-	0.025"
Max. doorstroomvolume - l/min (gpm)	1.8 (0.47)	1.8 (0.47)	2.3 (0.6)	4.1 (1.1)
Max. Druk - bar (PSI)	227 (3300)	227 (3300)	227 (3300)	227 (3300)
Batterijvermogen - Volt (Ah)	2x 54V DeWalt® FlexVolt 6.0 Ah accu's	2x 54V DeWalt® FlexVolt 9.0 Ah accu's	Lithium van 12 V (100)	2x Lithium van 12 V (100)
Gewicht - kg (lbs)	14 (31)	55 (121)	131 (288)	165 (364)
KENMERKEN				
LiveLook-scherm				■
Hydraulische drukmeter	■	■	■	
Smartcontrol™			■	■
FastFlush™			■	
Endurance™-pomp	Mechanisch	Mechanisch	Mechanisch	Mechanisch
EZ Align™-systeem			■	■
EasyMark-systeem		■	■	■
Quickselect™-pistoolkiezer			Handmatig	Handmatig
Pistoolmontage aan de achterzijde			■	■
Dualcomfort™-stuurhendelsysteem			■	■
LineDriver™**			Optioneel	Optioneel
ProConnect™	■	■	■	
SAMENSTELLING				
Spuittips	286419	LL5317 + LL5419	LL5319 + LL5421	LL5319 + LL5421
Spuittiphouder	RAC V (243161)	RAC V (243161)	RAC V (243161)	RAC V (243161)
Verlenging	40 cm (223718)			
Pistool	Flex Plus™ (248157)	Flex Plus™ (248157)	Flex Plus™ (248157)	Flex Plus™ (248157)
Slang	Blue Max™ II 1/4" x 15 m (249080)	Blue Max™ II 1/4" x 15 m (249080)	Blue Max™ II 1/4" x 15 m (249080)	BlueMax™ II 3/8" x 6.7 m (124884)
Pompfilter (maasgrootte)	60 (243984)	60 (243984)	60 (243984)	50 (24V455)
Stroomvoorziening	2x 54V DeWalt® FlexVolt 6.0 Ah accu's met DeWalt® ventilatorgekoelde snellader	2x 54V DeWalt® FlexVolt 9.0 Ah accu's met DeWalt® ventilatorgekoelde snellader	1 accu van 12V, met 230V-omvormer en kabelset van 30 cm (EU, IT, DK, CH, VK)	2 accu's van 12 V, met 230V-omvormer en kabelset van 30 cm (EU, IT, DK, CH, VK)
TSL™	118ml (238049)	118ml (238049)	118ml (238049)	118ml (238049)
PRIJZEN	25U514: € 4.000,00	25U547: € 9.800,00	25U675: € 17.700,00	25U681: € 26.300,00 25U685: € 27.700,00
BROCHURE	300720**	300720**	300720**	300720**

* Zie pagina 44 voor meer informatie over LineDriver.

** Zie de catalogus "Onderhoudsoplossingen voor wegmarkeringen" voor het complete productassortiment.



SPECIFICATIES & PRIJZEN

WEGMARKERING - 2



TECHNISCHE GEGEVENS	LINELAZER™ V STANDARD			LINELAZER™ V STANDARD		
	3400	130HS	3900	5900	200HS	200DC
Artikelnummer - 1 pistool	25M224	17H447	17H449	17H454	17H459	-
Artikelnummer - 2 pistolen	-	17H448	17H450	17H455	17H461	17Y231
Max. spuittipformaat - 1 pistool	0.027"	0.037"	0.035"			
Max. spuittipformaat - 2 pistolen	-	0.029"	0.025"			
Max. doorstroomvolume - l/min (gpm)	2.8 (0.75)	4.9 (1.3)	4.7 (1.25)			
Max. Druk - bar (PSI)	227 (3300)	227 (3300)	227 (3300)	227 (3300)	227 (3300)	227 (3300)
Motorvermogen - cm ³	120	120	120	160	200	200
Gewicht - kg (lbs)	72.5 (160)	119 (263)	104 (230)	113 (250)	139 (306)	173 (381)
KENMERKEN						
LiveLook-scherm			■	■	■	■
Endurance™-pomp	Mechanisch	Hydraulisch	Mechanisch	Mechanical	Hydraulic	Hydraulic
AVRS		■	■	■	■	■
EZ Align™-systeem		■	■	■	■	■
EasyMark-systeem	■	■	■	■	■	■
Quick Select™-pistoolkiezer		Handmatig	Handmatig	Handmatig	Handmatig	Handmatig
Pistoolmontage aan de achterzijde		■	■	■	■	■
Dualcomfort™-stuurhendelsysteem		■	■	■	■	■
Linedrive™*		Optioneel	Optioneel	Optioneel	Optioneel	Optioneel
SAMENSTELLING						
Spuittips	LL5317 + LL5319	LL5319 + LL5421	LL5319 + LL5421	LL5319 + LL5421		
Spuittiphouder	RAC V (243161)			RAC V (243161)		
Pistool	Flex Plus™ (248157)			Flex Plus™ (248157)		
Slang	Blue Max™ II 1/4" x 15 m (249080)	Blue Max™ II 3/8" x 6.7 m (124884)	Blue Max™ II 3/8" x 15 m (245225)	Blue Max™ II 3/8" x 15 m (245225)	Blue Max™ II 3/8" x 6.7 m (124884)	Blue Max™ II 3/8" x 3.6 m (191239)
Pompfilter (maasgrootte)	60 (243984)	50 (24V455)		50 (24V455)		
Brandstofcapaciteit - L (gal)		2.5 (0.66)			3.6 (0.95)	
TSL™		118ml (238049)		118ml (238049)		
PRIJZEN						
	25M224: € 12.465,00	17H447: € 17.955,00	17H449: € 16.615,00	17H454: € 18.660,00	17H459: € 22.525,00	
		17H448: € 19.300,00	17H450: € 18.025,00	17H455: € 20.080,00	17H461: € 23.940,00	17Y231: € 32.435,00
BROCHURE	300720**	300720**	300720**	300720**	300720**	300720**

* Zie pagina 44 voor meer informatie over LineDriver.

** Zie de catalogus "Onderhoudsoplossingen voor wegmarkeringen" voor het complete productassortiment.

SPECIFICATIES & PRIJZEN

WEGMARKERING - 3



TECHNISCHE GEGEVENS	LINEDRIVER™		
	160	HD 200	ES
Part Number	262004	262005	25U671
Motor Engine - cc (hp)	160 cm ³	200 cm ³	3x 24 V, 50 Ah Lithium
Fuel Capacity - L (gal)	3.6 (0.95)	3.6 (0.95)	-
Weight kg - (lb)	120 (266)	125 (277)	174 (384)
PRIJZEN			
	262004: € 14.120,00	262005: € 14.990,00	25U671: € 29.255,00
BROCHURE			
	300720	300720	300720

*Alle LineDriver-toestellen kunnen worden gebruikt op de LineLazer, de ThermoLazer en de HP GrindLazer
 ** Zie de catalogus "Onderhoudsoplossingen voor wegmarkeringen" voor het complete productassortiment.



SPECIFICATIES & PRIJZEN

OPPERVLAKTEVOORBEREIDING



TECHNISCHE GEGEVENS	GRINDLAZER™				GRINDLAZER™			
	STANDARD DC21 E	STANDARD RC71 E	STANDARD DC87 G	STANDARD DC89 G	PRO DC1013 G	PRO RC813 G	HP DC89 G	HP DC1013 G
Artikelnummer (alleen toestel)*	25N391	25N392	25M842	25M843	25M846	25M847	25M992	25M993
Artikelnummer (alleen toestel) met DCS*	-	-	-	-	-	25N669	-	25N658
Snijderstype	Trommel	Draaiend	Trommel	Trommel	Trommel	Draaiend	Trommel	Trommel
Max. werkbreedte	5 cm (2")	17.5 cm (7")	20 cm (8")	20 cm (8")	25 cm (10")	20 cm (8")	20 cm (8")	25 cm (10")
Diameter snijdertrommel	10 cm (4")	-	12.5 cm (5")	12.5 cm (5")	17.5 cm (7")	-	17.5 cm (7")	17.5 cm (7")
Motor - cc (pk)	230V Makita	230V Makita	Honda 200 (6.5)	Honda 270 (9)	Honda 390 (13)	Honda 390 Vertical (13)	Honda 270 (9)	Honda 390 (13)
Motorstart	-	-	Trekstart	Trekstart	Trekstart	Elektrische starter	ProStart	ProStart (25M993) Elektrische starter (25N658)
Toerenteller/urenteller	-	-	■	■	■	■	■	■
Max. snijsnelheid (open) - m ² /u (sq ft/hr)	10 m ² /h (100 sq ft/h)	10 m ² /h (100 sq ft/h)	30 m ² /h (300 sq ft/h)	40 m ² /h (400 sq ft/h)	65 m ² /h (700 sq ft/h)	75 m ² /h (800 sq ft/h)	55 m ² /h (600 sq ft/h)	75 m ² /h (800 sq ft/h)
Max. snijsnelheid (LineDriver/Skid loader)	-	-	-	-	-	-	120 m ² /h (1300 sq ft/h)	160 m ² /h (1700 sq ft/h)
Gewicht - kg (lb)	5.4 (12)	6.8 (15)	57 (125)	68 (150)	114 (250)	204 (450) (25M847) 216 (475) (25N669)	136 (300)	141 (310) (25M993) 161 (355) (25N658)
KENMERKEN								
Stofzuigermond	■	■	■	■	■	■	■	■
Luchtfilter	-	-	Cyclone™	Cyclone™	Cyclone™	Standard	Cyclone™	Cyclone™
Wateraansluiting voor stofonderdrukking	-	-	Optioneel	Optioneel	Optioneel	NEE	Optioneel	Optioneel
Compatibel met LineDriver/schranklader	-	-	NEE	NEE	NEE	NEE	Optionele LineDriver	Optionele LineDriver
PRIJZEN								
	25N391: € 1.740,00	25N392: € 2.085,00	25M842: € 3.790,00	25M843: € 4.560,00	25M846: € 8.510,00	25M847: € 12.255,00 25N669: € 14.440,00	25M992: € 9.750,00	25M993: € 12.315,00 25N658: € 14.785,00
BROCHURE	344384	344384	344384	344384	344384	344384	344384	344384

* Alle machines worden zonder drum geleverd dus zie de catalogus "Freessystemen" voor meer informatie over de ondersteunde drums

** Zie de catalogus "Freessystemen" voor het complete product assortiment



ACCESSOIRES

SPECIFICATIES & PRIJZEN

Accessoires Kleine klussen	54 - 57
Accessoires Fijne Afwerking	58 - 61
Accessoires Professionele Airless	62 - 87
Accessoires Airless Structuur	88 - 95
Accessoires Heavy Duty	96 - 97
Accessoires Professionele Reinigings	98 - 99
Algemene onderdelen	100 - 101



De exclusieve Flexliner™ technologie zorgt voor snel opstarten, spuiten en schoonmaken van je Ultra Airless Handheld™, geeft je de mogelijkheid om in elke richting te spuiten - zelfs ondersteboven - en biedt een ongeëvenaarde draagbaarheid.

KLEINE KLUSSEN - 1

ULTRA AIRLESS HANDHELD

	ARTIKELNUMMER	OMSCHRIJVING	EURO
	17P550	BEKER COMPLEET, 1 L (32 OZ) STANDARD, ULTRA HANDHELD	€ 29,00
	17P551	BEKER COMPLEET, 1 L (32 OZ), OPLOSMIDDEL, ULTRAMAX HANDHELD	€ 29,00
	17P552	BEKER COMPLEET, 1.25 L (42 OZ) STANDARD, ULTRA HANDHELD	€ 40,00
	17P553	BEKER COMPLEET, 1.25 L (42 OZ) STANDARD, ULTRAMAX HANDHELD	€ 40,00
	17A226	BEKERZAKJES, 1L (32 OZ) (X3)	€ 9,20
	17P212	BEKERZAKJES, 1L (32 OZ) (X25)	€ 56,00
	17F005	BEKERZAKJES, 1.25L (42 OZ) (X3)	€ 11,00
	17P549	BEKERZAKJES, 1.25L (42 OZ) (X25)	€ 65,00
	17N392	BEKER, 1 L (32 OZ)	€ 17,00
	17D850	BEKER, 1.25 L (42 OZ)	€ 19,00
	17N515	DEKSEL BEKER, STANDARD, ULTRA HANDHELD	€ 11,00
	17N517	DEKSEL BEKER, OPLOSMIDDEL, ULTRAMAX HANDHELD	€ 13,00
	17M879	AFDICHTINGSDOP BEKER, ULTRA HANDHELD	€ 13,00
	17P554	MATERIAALFILTER - MAASGROOTTE 60 (X3)	€ 19,00
	17P555	MATERIAALFILTER - MAASGROOTTE 100 (X3)	€ 19,00
	17P501	ZITTING/DICHRING - STANDARD, ULTRA HANDHELD (X5)	€ 46,00
	17P502	ZITTING/DICHRING - OPLOSMIDDEL, ULTRAMAX HANDHELD (X5)	€ 46,00
	17P557	BATTERIJ 18V 2.0 AH LITHIUM ION , ULTRA(MAX) HANDHELD	€ 195,00
	17P560	LAADTOESTEL, ULTRA(MAX) HANDHELD, 230V	€ 172,00
	17M883	OPBERGTAS	€ 58,00
	253574	PUMP ARMOR VLOEIBARE BESCHERMING, 1L (32 OZ)	€ 41,00
	246215	RAC X TIPHOUDER 7/8", ULTRA HANDHELD, MATERIALEN OP WATERBASIS	€ 61,00
	17P573	RAC X TIPHOUDER 1", ULTRAMAX HANDHELD, OPLOSMIDDELBESTENDIG	€ 61,00

	ARTIKELNUMMER	OMSCHRIJVING	EURO
	287019	25 CM TIPVERLENGSTUK MET RAC X TIPHOUDER (ALLEEN VOOR ULTRA HH)	€ 97,00
	287020	40 CM TIPVERLENGSTUK MET RAC X TIPHOUDER (ALLEEN VOOR ULTRA HH)	€ 112,00
	16H256	AARDINGSKABEL	€ 54,00
	17P712	VACUVALVE AFDICHTINGSDOP (X3)	€ 5,80
	18B057	FLEXLINER QUICKIILL TRECHTER EN ZEEF	€ 29,00
	25T467	SEAL LUBE STICK VOOR LUCHTDICHTE AFSLUITING VAN DE CUP	€ 2,80
	17P185	TRIAX POMP ULTRA HANDHELD AC	€ 252,00
	17P186	TRIAX POMP ULTRA HANDHELD DC	€ 252,00
	17P187	TRIAX POMP ULTRAMAX HANDHELD DC	€ 252,00





PRIJSLIJST IN EURO



Geniet van de ultieme handsfree draagbaarheid met de riem en holster die bij je Ultra QuickShot worden geleverd.

KLEINE KLUSSEN - 2

ULTRA QUICKSHOT

ARTIKELNUMMER	OMSCHRIJVING		
 18H073	MATERIAALFILTER - MAASGROOTTE 60 (X3)	€	21,00
 18H074	MATERIAALFILTER - MAASGROOTTE 100 (X3)	€	21,00
 18F891	QUICKSHOT RIEM	€	25,00
 18F977	QUICKSHOT HOLSTER	€	46,00
 17M883	OPBERGTAS	€	58,00
18H080	OPBERPLUG DEKSEL (X3)	€	12,00
18H079	BEKER EN DEKSEL	€	78,00
 246215	TIPHOUDER	€	61,00
17P557	DEWALT 18V 2.0 AH MAX LITHIUM-ION BATTERIJ	€	195,00
17P560	DEWALT OPLADER, 230V	€	172,00
18H072	QUICKSHOT VERVANGPOMP	€	284,00
18H059	QUICKSHOT VERVANGPISTOOL	€	361,00
2000354	QUICKSHOT VERVANGSLANG	€	144,00





Snelle verwisseling van naalden.
Verwissel naalden vanaf de voorzijde van het pistool middels een eenvoudige klik.
Gemakkelijk te verwisselen, gemakkelijk te reinigen, zonder benodigd gereedschap.

HVLP PISTOLEN & ACCESSOIRES

HVLP EDGE II PISTOLEN EN ACCESSOIRES

	ARTIKELNUMMER	OMSCHRIJVING	EURO
	17P481	HVLP 'EDGE II' PISTOOL, 1L (32 OZ) FLEXLINER BEKER, SET NAALD EN LUCHTKAP #3 (17P486), AFSTANDBEGRENZER TREKKER	€ 693,00
	17P653	HVLP 'EDGE II' PISTOOL, SIFONBEKER, SET NAALD EN LUCHTKAP #3 (17P486), AFSTANDBEGRENZER TREKKER	€ 632,00
	17P483	HVLP 'EDGE II PLUS' PISTOOL, 1L (32 OZ) FLEXLINER BEKER, SET NAALD EN LUCHTKAP #3 (17P486), AFSTANDBEGRENZER TREKKER, LUCHTREGELAAR, VENTILATORREGELAAR	€ 773,00
	17P484	HVLP 'EDGE II PLUS' PISTOOL, SIFONBEKER, SET NAALD EN LUCHTKAP #3 (17P486), AFSTANDBEGRENZER TREKKER, LUCHTREGELAAR, VENTILATORREGELAAR	€ 665,00
	17P654	HVLP 'EDGE II PLUS PROCOMP' PISTOOL, ZONDER BEKER, SET NAALD EN LUCHTKAP #3 (17P486), AFSTANDBEGRENZER TREKKER, LUCHTREGELAAR, VENTILATORREGELAAR	€ 615,00
	17P485	HVLP EDGE II QUICK RELEASE SET NAALD EN LUCHTKAP #2 (0.8 MM)	€ 88,00
	17P486	HVLP EDGE II QUICK RELEASE SET NAALD EN LUCHTKAP #3 (1.3 MM)	€ 88,00
	17P487	HVLP EDGE II QUICK RELEASE SET NAALD EN LUCHTKAP #4 (1.8 MM)	€ 88,00
	17P488	HVLP EDGE II QUICK RELEASE SET NAALD EN LUCHTKAP #5 (2.2 MM)	€ 88,00
	17P489	HVLP EDGE II QUICK RELEASE SET NAALD EN LUCHTKAP #6 (2.5 MM)	€ 88,00
	17P490	HVLP EDGE II QUICK RELEASE SET NAALD EN LUCHTKAP #7 (2.8 MM)	€ 88,00
	17P709	HVLP LUCHTKAP, 'EDGE II' PISTOOL	€ 79,00
	17P492	HVLP EDGE II PISTOOL BORGRING	€ 38,00
	17P493	HVLP EDGE II PLUS PISTOOL BORGRING	€ 38,00
	17P718	HVLP EDGE II AFSTANDBEGRENZER TREKKER, MATERIAAL REGELAAR	€ 109,00
	256927	HVLP ARTISAN LUCHTREGELAAR	€ 182,00
	17P491	HVLP EDGE II TIPVERLENSTUK, 30CM	€ 382,00

HVLP EDGE GUN ACCESSOIRES

ARTIKELNUMMER	OMSCHRIJVING	EURO
256946	HVLP EDGE QUICK RELEASE SET NAALD EN LUCHTKAP #2 (0.8 MM)	€ 125,00
256947	HVLP EDGE QUICK RELEASE SET NAALD EN LUCHTKAP #3 (1.33 MM)	€ 125,00
256948	HVLP EDGE QUICK RELEASE SET NAALD EN LUCHTKAP #4 (1.8 MM)	€ 125,00
256949	HVLP EDGE QUICK RELEASE SET NAALD EN LUCHTKAP #5 (2.2 MM)	€ 125,00
256950	HVLP EDGE QUICK RELEASE SET NAALD EN LUCHTKAP #6 (2.5 MM)	€ 125,00
256951	HVLP LUCHTKAP, 'EDGE ' PISTOOL	€ 130,00
256861	HVLP EDGE PISTOOL BORGRING	€ 56,00
257086	HVLP EDGE AFSTANDBEGRENZER TREKKER, MATERIAAL REGELAAR	€ 118,00
256952	HVLP EDGE TIPVERLENSTUK, 25 CM	€ 602,00

	EDGE I		EDGE II		EDGE II PLUS	
AFSTANDBEGRENZER TREKKER, MATERIAAL REGELAAR	257086	€ 118,00	17P718	€ 109,00	-	-
ARTISAN LUCHTREGELAAR	256927	€ 182,00	256927	€ 182,00	256927	€ 182,00
LUCHTKAP	256951	€ 130,00	17P709	€ 79,00	17P709	€ 79,00
PISTOOL BORGRING	256861	€ 56,00	17P492	€ 38,00	17P493	€ 38,00
TIPVERLENGSTUK	256952	€ 602,00	17P491	€ 382,00	17P491	€ 382,00

PRIJSLIJST IN EURO





Super-Flex™-luchtslang. De lichtere en flexibelere slang zorgt ervoor dat het pistool vlotter in de hand ligt en het werk minder vermoeiend is. Handige aansluitknop

HVLP BEKERS, DICHTINGEN, BINNENBEKERS & SLANGEN

HVLP BEKERS, DICHTINGEN & BINNENBEKERS

	PART NUMBER	DESCRIPTION	EURO	
	17R462	HVLP EDGE II BEKER, VOOR ONDERMONTAGE, 1L	€	148,00
	244132	HVLP EDGE BEKER, (ALLEEN BEKER), 1L	€	90,00
	244130	HVLP EDGE BEKER, VOOR ONDERMONTAGE, 1L	€	175,00
	257091	AFSTANDBEKER (ENKEL BEKER) 1L	€	86,00
	257098	AFSTANDBEKER 1L, DEKSEL, 1.5 M MATERIAAL + LUCHT SLANG	€	490,00
	287819	AFSTANDBEKER 2L, DEKSEL, 1.5 M MATERIAAL + LUCHT SLANG	€	629,00
	120126	AFSTANDBEKER (ENKEL BEKER) 2L	€	146,00
	17S115	BEKER, KOPSTAND, EDGE II, 0.5L	€	154,00
	17S116	BEKER, KOPSTAND, EDGE II PLUS, 0.5L	€	154,00
	240265	BEKERPAKKING, 1 LITER (5X)	€	48,00
	244953	PAKKINGSET 9.5 LITER POLYETHYLEEN (3X)	€	100,00

ACCESSOIRES FIJNE AFWERKING

	ARTIKELNUMMER	OMSCHRIJVING	EURO	
	17A226	BEKERZAKJES, 1L (32 OZ) (X3)	€	9,20
	17P212	BEKERZAKJES, 1L (32 OZ) (X25)	€	56,00
	240266	NAVULVERPAKKING, 1L (40X), HVLP	€	87,00
	112077	NAVULVERPAKKING DRUKTANK, 9.5 L (5X)	€	140,00
	112078	NAVULVERPAKKING DRUKTANK, 9.5 L (25X)	€	383,00

HVLP SLANGEN

	ARTIKELNUMMER	OMSCHRIJVING	EURO	
	240475	MATERIAALSLANG, DRUK, 3/8", 6M	€	174,00
	240476	MATERIAALSLANG, DRUK, 3/8", 9M	€	246,00
	240477	MATERIAALSLANG, DRUK, 3/8", 12M	€	372,00
	240478	SLANG, MATERIAAL, DRUK, 3/8", 15M	€	481,00
	17R300	EDGE II SUPER-FLEX LUCHTSLANG, 3/4" BINNENDIAMETER, 6M	€	125,00
	257159	SUPER-FLEX LUCHTSLANG, 3/4" BINNENDIAMETER, 9M	€	215,00
	241414	SUPER-FLEX LUCHTSLANG, 3/4" BINNENDIAMETER, 12M	€	248,00
	241423	SUPER-FLEX LUCHT- & MATERIAALSLANG, 9M	€	595,00
	17R299	EDGE II SUPERFLEX HULPSLANG LUCHT, 3/4" BINNENDIAMETER, 1.2M	€	79,00



Voor grotere klussen die een fijne afwerkwaliteit vergen, kan de 1-literbeker na uren spuiten vermoeidheid in de hand werken. ProComp™ kan u het werk aanzienlijk lichter en comfortabeler maken omdat deze externe compressor het mogelijk maakt om het materiaal van het pistool te scheiden. De krachtige compressor kan aan om het even welk HVLP TurboForce™-spuittoestel vastgemaakt worden: het vraagt enkele luttele seconden en dit zonder gereedschap. Geen regelaars (sets beschikbaar voor manuele instellingen).

HVLP ACCESSOIRES: DIVERS

ARTIKELNUMMER	OMSCHRIJVING	EURO
 240069	Y-AANSLUITING, 2 SLANGEN	€ 114,00
 240282	SET VOOR SNELLE ONTKOPPELING, TURBINELUCHT	€ 90,00
 244133	LUCHTSLANGETJE , HVLP S PISTOOL(5X)	€ 44,00
 244135	REDUCEERVENTIEL HVLP BEKER (X5)	€ 68,00
 256953	HVLP REINIGINGSSET, NAALDEN + BORSTELS	€ 66,00
 256954	DELUXE HVLP REINIGINGSSET, NAALDEN + BORSTELS	€ 171,00
 256957	QUICKCLEAN ONTLUCHTINGSVENTIEL	€ 75,00
 256956	QUICKCLEAN ONTLUCHTINGSVENTIEL (3X)	€ 105,00
 256959	SCHOUDERRIEM HVLP BEKER	€ 66,00
 M70702	VISCOSITEITSBEKER, FORD 4	€ 154,00
 193218	HVLP AANZUIGFILTER, KONISCH	€ 14,00
 240267	HVLP AANZUIGFILTER (X3)	€ 45,00
 240273	HVLP TURBINE FILTER SET	€ 144,00
 240274	HVLP TURBINE FILTER SET (5X)	€ 76,00
 15W909	HVLP TURBINE FILTERSCHUIM	€ 14,00



Ervaar airless als nooit tevoren met de Contractor PowerShot Standard. Dit elektronisch aangedreven airless pistool elimineert nagenoeg alle spuittipsputteren en beschikt over de gevoeligste trekker in de branche, voor comfortabel spuiten gedurende de hele dag met één batterijlading.

CONTRACTOR POWERSHOT



ARTIKELNUMMER	OMSCHRIJVING	EURO
 18H304	CONTRACTOR POWERSHOT STANDARD PISTOOL, RAC X, LP517, POWERPAK SYSTEEM, 2x HULPSLANG, PISTOOLFILTER 60 MESH, POWERSHOT RIEM EN HOLSTER, 2 BATTERIJEN EN 1 LADER, CEE	€ 950,00
 18H302	CONTRACTOR POWERSHOT STANDARD PISTOOL, RAC X, LP517, POWERPAK SYSTEEM, 2x HULPSLANG, PISTOOLFILTER 60 MESH, POWERSHOT RIEM EN HOLSTER, 2 BATTERIJEN EN 1 LADER, UK	€ 950,00
 18H305	CONTRACTOR POWERSHOT XT PISTOOL, RAC X, LP517, POWERPAK SYSTEEM, 2x HULPSLANG, PISTOOLFILTER 60 MESH, POWERSHOT RIEM EN HOLSTER, 2 BATTERIJEN EN 1 LADER, CEE	€ 1115,00
 18H303	CONTRACTOR POWERSHOT XT PISTOOL, RAC X, LP517, POWERPAK SYSTEEM, 2X HULPSLANG, PISTOOLFILTER 60 MESH, POWERSHOT RIEM EN HOLSTER, 2 BATTERIJEN EN 1 LADER, UK	€ 1115,00
 18H314	CONTRACTOR POWERSHOT XT PISTOOL, RAC X, LP517, POWERPAK SYSTEEM, 2X HULPSLANG, PISTOOLFILTER 60 MESH, POWERSHOT RIEM EN HOLSTER, 2 BATTERIJEN EN 1 LADER, SMARTDISPLAY XT INBEGREPEN, CEE	€ 1225,00
 18H315	CONTRACTOR POWERSHOT XT PISTOOL, RAC X, LP517, POWERPAK SYSTEEM, 2X HULPSLANG, PISTOOLFILTER 60 MESH, POWERSHOT RIEM EN HOLSTER, 2 BATTERIJEN EN 1 LADER, SMARTDISPLAY XT INBEGREPEN, UK	€ 1225,00
 2006609	POWERSHOT HULPSLANG VOOR MATERIAALTOEVOER, 1/8" X 45CM	€ 74,00
 2006608	HULPSLANG POWERSHOT PISTOOL, 1/8" X 1.8M	€ 400,00
 2005788	CONTRACTOR POWERSHOT PROCONNECT VERVANGENDE CARTRIDGE	€ 117,00
 20B432	SMARTDISPLAY XT	€ 189,00
 18F891	RESERVERIEM	€ 25,00
 2006715	POWERSHOT HOLSTER	€ 46,00
 287019	25 CM TIPVERLENGSTUK MET RAC X TIPHOUDER (ALLEEN VOOR ULTRA HH)	€ 97,00
 287020	40 CM TIPVERLENGSTUK MET RAC X TIPHOUDER (ALLEEN VOOR ULTRA HH)	€ 112,00
 17P557	DEWALT 18V 2.0 AH MAX LITHIUM-ION BATTERIJ	€ 195,00
 17P560	DEWALT OPLADER, 230V	€ 172,00











Bij het selecteren van een pistool moet rekening worden gehouden met diverse factoren, waaronder de maat van de vloeistofdoorlaat en vernevelaar, de nominale druk en het comfort en de hanteerbaarheid van het pistool.

AIRLESS (LUCHTONDERSTEUNDE) PISTOLEN

ARTIKELNUMMER	OMSCHRIJVING	EURO
 17Y043	CONTRACTOR PC PISTOOL, RAC X, LP517	€ 479,00
 19Y350	CONTRACTOR PC COMPACT PISTOOL, RAC X, LP517	€ 479,00
 262932	G40 PISTOOL, PLATTE SPUITTIP AAM309 (INCL. VENTILATORREGELAAR)	€ 1323,00
262929	G40 PISTOOL, RAC-SPUITTIP FFA210 (ZONDER VENTILATORREGELAAR)	€ 1323,00
17J910	SG3 PISTOOL, 4 VINGERS, RAC X TIPHOUDER, PAA515	€ 376,00
 288438	FTX-E PISTOOL, 4 VINGERS, RAC X TIPHOUDER, PAA517	€ 377,00
 288475	CONTRACTOR PISTOOL, 2 VINGERS, RAC X TIPHOUDER, PAA517	€ 421,00
 246240	PRO SILVER-PISTOOL MET RAC X (LTX517) TIP EN RAC X TIPHOUDER, 345BAR	€ 582,00
235460	SILVER PISTOOL, 2-VINGERS	€ 550,00
235461	SILVER-PISTOOL, 4-VINGERS, TIPHOUDER, ZONDER TIP	€ 550,00
235462	SILVER-PISTOOL, 2-VINGERS, PLATTE TIP, TIPHOUDER, ZONDER TIP	€ 550,00
235465	SILVER-PISTOOL, 2 VINGERS	€ 842,00
 289605	HD BLUE PLASTER PISTOOL, RAC X TIPHOUDER, 531 TIP	€ 712,00

ARTIKELNUMMER	OMSCHRIJVING	EURO
 245820	HD INLINE PLASTER PISTOOL	€ 1000,00
 244364	CONTRACTOR, IN-LINE PISTOOL MET FILTER, 250 BAR	€ 428,00
 246468	FLEX-PISTOOL, RAC X 517	€ 507,00
224472	MASTIEK PISTOOL, 36" (90CM), EXTENSION	€ 1504,00
248947	OVERSPRAY REDUCTIE SET (LL5321, LL5419, 287030, 243295 EN 246538)	€ 872,00

BETONINJECTIESYSTEMEN

ARTIKELNUMMER	OMSCHRIJVING	EURO
 17E247	INJECTIESET, METER, FLEXIBEL VOOR PISTOOL	€ 161,00
 17E248	INJECTIESET, METER, VAST VOOR PISTOOL	€ 141,00
 17E249	INJECTIESET, METER, FLEXIBEL EN VENTIEL	€ 279,00
 17E250	INJECTIESET, METER, VAST EN VENTIEL	€ 251,00
 17E251	INJECTIESET, FLEXIBEL VOOR PISTOOL	€ 103,00
 17E252	INJECTIESET, VAST VOOR PISTOOL	€ 86,00
 17E253	INJECTIESET, FLEXIBEL EN VENTIEL	€ 256,00
 17E254	INJECTIESET, VAST EN VENTIEL	€ 243,00



OPTIMALE STROMING EN DRUK

Bij verlenging van de slanglengte (langer dan 15 m) wordt het aanbevolen om de diameter van de slang te vergroten.

AIRLESS (LUCHTONDERSTEUNDE) SLANGEN

ARTIKELNUMMER	OMSCHRIJVING	EURO
214981	BLUE MAX II SLANG 3/16" X 4,5 M (FBE = VROUWELIJK BEIDE KANTEN), 227 BAR	€ 90,00
214698	BLUE MAX II SLANG 3/16" X 7,5 M, 1/4"18NPSM (FBE), 227 BAR	€ 114,00
214697	BLUE MAX II SLANG 3/16" X 15 M, 1/4"18NPSM (FBE), 227 BAR	€ 170,00
223756	BLUE MAX II SLANG 1/4" X 4,5 M, 1/4"18NPSM (FBE), 227 BAR	€ 90,00
240793	BLUE MAX II SLANG 1/4" X 7,5 M, 1/4"18NPSM (FBE), 227 BAR	€ 122,00
240794	BLUE MAX II SLANG 1/4" X 15 M, 1/4"18NPSM (FBE), 227 BAR	€ 203,00
241272	BLUE MAX II SLANG 1/4" X 20 M, 1/4"18NPSM (FBE), 227 BAR	€ 244,00
223771	BLUE MAX II SLANG 1/4" X 30 M, 1/4"18NPSM (FBE), 227 BAR	€ 336,00
277250	BLUE MAX II SLANG 1/4" X 15 M, 1/4"18NPSM (FBE), 276 BAR	€ 442,00
278499	BLUE MAX II SLANG 1/2"X 15M, 1/2"14NPSM (FBE), 227 BAR	€ 796,00
240796	BLUE MAX II SLANG 3/8" X 7,5 M, 1/4"18NPSM (FBE), 227 BAR	€ 224,00
240797	BLUE MAX II SLANG 3/8" X 15 M, 1/4"18NPSM(FBE), 227 BAR	€ 357,00
241275	BLUE MAX II SLANG 3/8" X 30 M, 1/4"18NPSM (FBE), 227 BAR	€ 643,00
277251	BLUE MAX II SLANG 3/8" X 15 M, 3/8"18NPSM (FBE), 276 BAR	€ 678,00
238358	BLUE MAX II HULPSLANG 3/16" X 0,9 M, 1/4"18NPSM (M X V), 227 BAR	€ 63,00
238959	BLUE MAX II HULPSLANG 3/16" X 1,4 M, 1/4"18NPSM (M X V), 227 BAR	€ 74,00
238359	BLUE MAX II HULPSLANG 3/16" X 1,8 M, 1/4"18NPSM (M X V), 227 BAR	€ 84,00
25C827	BLUE MAX II HULPSLANG 1/8" X 0,9 M, 1/4"18NPSM (M X V), 227 BAR	€ 61,00
25C828	BLUE MAX II HULPSLANG 1/8" X 1,4 M, 1/4"18NPSM (M X V), 227 BAR	€ 68,00
277249	BLUE MAX II HULPSLANG 1/4" X 0,9 M, 1/4"(V) X 3/8"(M) 18NPSM, 276 BAR	€ 122,00
241735	BLUE MAX II HULPSLANG 1/4" X 0,9M, 1/4"(F) X 1/4"(M) 18NPSM, 227 BAR	€ 88,00
277351	BLUE MAX II HULPSLANG 3/8" X 0,9 M 1/4"(V) X 1/2"(M) 18NPSM, 276 BAR	€ 179,00
191239	BLUE MAX II HULPSLANG 3/8" X 3,5 M, 3/8" 318NPSM FXF, 227 BAR	€ 188,00



ARTIKELNUMMER	OMSCHRIJVING	EURO
289959	T-MAX 506/657/6912 HULPSLANG 3/4" X 3M, CAM M X F, 69 BAR	€ 502,00
26A802	T-MAX 506/657/6912 HULPSLANG, 3/4" X 10M, ZWART V X M, 69 BAR	€ 773,00
289960	T-MAX 506/657/6912 SLANG 1" X 5M, CAM M X F, 69 BAR	€ 825,00
289961	T-MAX 506/657/6912 SLANG, 1" X 10M, CAM M X F, 69 BAR	€ 1248,00
17Z187	T-MAX 506/657/6912 SLANG, 1" X 15M, CAM M X F, 69 BAR	€ 1824,00
17Z188	T-MAX 506/657/6912 SLANG, 1" X 30M, CAM M X F, 69 BAR	€ 3159,00
18A560	T-MAX 506/657/6912 COMPATIBEL MET OPLOSMIDDELEN, 3/4" X 15M, CAM M X F, 69 BAR	€ 1373,00
18A559	T-MAX 506/657/6912 COMPATIBEL MET OPLOSMIDDELEN, 3/4" X 30M, CAM M X F, 69 BAR	€ 2764,00
248557	T-MAX, LUCHTSLANGSET, 3/8"X15M +REGELAAR	€ 277,00
17J420	BLAUWE DOORZICHTIGE SLANGENSET, 1" X 7,5M	€ 604,00
17J421	BLAUWE DOORZICHTIGE SLANGENSET, 1" X 15M	€ 729,00
17J454	BLAUWE DOORZICHTIGE SLANGENSET, 3/4" X 7,5M	€ 479,00
17L000	HEAVY-DUTY-SLANGENSETS, 1" X 7,5M	€ 729,00
17L003	HEAVY-DUTY-SLANGENSETS, 1" X 15M	€ 974,00
17L005	HEAVY-DUTY-SLANGENSETS, 1-1/4" X 7,5M	€ 1098,00
17L009	HEAVY-DUTY-SLANGENSETS, 1-1/4" X 15M	€ 1671,00
17L010	HEAVY-DUTY-HULPSLANGENSETS, 1" X 3M	€ 510,00
287314	ROTOFLEX PUMP, SLANG	€ 180,00
256976	7,5M MATERIAAL/LUCHTSLANG, FINISPRO 290	€ 401,00
257520	7,5M MATERIAAL/LUCHTSLANG, FINISPRO290 (ALS VERLENGSTUK)	€ 401,00
24U578	SUPER-FLEX-MATERIAAL- EN LUCHTSLANGENSET 7,5M, INCLUSIEF HULPSLANG (2 M)	€ 411,00
24U579	SUPER-FLEX-MATERIAAL- EN LUCHTSLANGENSET 15M, INCLUSIEF HULPSLANG (2 M)	€ 614,00
278750	SUPER-FLEX-HULPSLANG, 1/8" X 2M	€ 92,00
17N982	SUPER-FLEX-HULPSLANG, 1/2" X 4,5M (APX)	€ 310,00
24U576	FLEX WRAP-SLANGBESCHERMING 7,5M	€ 83,00
24U577	FLEX WRAP-SLANGBESCHERMING 15M	€ 147,00
17N984	X-FLO SLANG 5/8" X 15M (APX)	€ 1243,00





OPTIMAAL SPUITRENDEMENT

Of het nu gaat om het vervangen van uw versleten spuitsets of dat u afzonderlijke spuitlijnen wilt voor materialen op oplosmiddelbasis en materialen op waterbasis: voor beide pistooltypen bestaan complete pistool/tip/slangensets.

AIRLESS (LUCHTONDERSTEUNENDE) PISTOLEN, TIPS & SLANGENSETS



ARTIKELNUMMER	OMSCHRIJVING	EURO
 17Y051	CONTRACTOR PC PISTOOL, RAC X, LP517, 1/4" X 15M + HULPSLANG 3/16" X 1.5M	€ 594,00
 17Y220	CONTRACTOR PC PISTOOL, RAC X, FFLP210 + FFLP312, 3/16" X 7.5M, 25CM EXTENSIE + 2 X 100 MAASGROOTTE FILTERS + OPLOSMIDDELKIT)	€ 594,00
 19Y445	CONTRACTOR PC COMPACT PISTOOL, RAC X, LP517, HULPSLANG 1/8" X 1.4M	€ 520,00
 19Y489	CONTRACTOR PC COMPACT PISTOOL, RAC X, LP517, 1/4" X 15M + HULPSLANG 1/8" X 1.4M	€ 588,00
24V155	G40-PISTOOL, SPUITTIP, HULPSLANG, SUPER-FLEX-MATERIAAL- EN LUCHTSLANGENSET 7,5M (GELEVERD MET 262932 + 24U578)	€ 1507,00
 24V156	G40-PISTOOL, SPUITTIP, HULPSLANG, SUPER-FLEX-MATERIAAL- EN LUCHTSLANGENSET 15M (GELEVERD MET 262929 + 24U579)	€ 1612,00
288499	FTX-E PISTOOL, 4 VINGERS, RAC V (517,60M), 1/4" X 15M + HULPSLANG 3/16" X 0.9M	€ 568,00
289611	HD BLUE PLASTER PISTOOL, RAC X (427,531), 3/8" X 15M + HULPSLANG 1/4" X 0.9M	€ 1089,00



RAC X tip compatibel met RAC X tiphouder



AIRLESS TIPHOUDERS







ARTIKELNUMMER	OMSCHRIJVING	EURO
 246215	RAC X TIPHOUDER 7/8" - SCHROEFDRAAD GRACO	€ 61,00
 246437	RAC X TIPHOUDER 11/16" - SCHROEFDRAAD EU	€ 61,00
246770	RAC X TIPHOUDER M18 X 1.5	€ 98,00
 243161	RAC V TIPHOUDER 7/8" - GRACO SCHROEFDRAAD	€ 84,00
243263	RAC V TIPHOUDER 11/16" - SCHROEFDRAAD EU	€ 84,00
220247	TIPHOUDER, FF 163 TIP 7/8" - SCHROEFDRAAD GRACO - 250 bar	€ 84,00
220249	TIPHOUDER, FF 163 TIP 11/16" - SCHROEFDRAAD EU - 250 bar	€ 98,00
220251	TIPHOUDER, 163/269 TIP 7/8" - SCHROEFDRAAD GRACO - 350 bar	€ 61,00
220255	TIPHOUDER, 163/269 TIP 11/16" - SCHROEFDRAAD EU - 350 bar	€ 61,00
224454	TIPFILTER, MAASGROOTTE 60 (5X)	€ 127,00
238564	TIPFILTER, MAASGROOTTE 60 (25X)	€ 393,00
224453	TIPFILTER, MAASGROOTTE 100 (5X)	€ 131,00
238562	TIPFILTER, MAASGROOTTE 100 (25X)	€ 393,00
220254	TIPFILTER 1 X MAASGROOTTE 60 + 1 X MAASGROOTTE 100 + TIPHOUDER)	€ 119,00
127465	WEGWERPBARE, INGEBOUWDE LUCHTFILTER VOOR DROOGMIDDEL	€ 16,00
24U981	WEGWERPBARE, INGEBOUWDE LUCHTFILTER VOOR DROOGMIDDEL (SET VAN 5)	€ 67,00
24U982	WEGWERPBARE, INGEBOUWDE LUCHTFILTER VOOR DROOGMIDDEL (SET VAN 25)	€ 298,00
246215	RAC X TIPHOUDER 7/8", STANDARD, ULTRA HANDHELD	€ 61,00
17P573	RAC X TIPHOUDER 1", OPLOSMIDDEL, ULTRAMAX HANDHELD	€ 61,00



VERGROOT UW BEREIK

Een uitgebreide reeks accessoires is ontwikkeld voor een aanzienlijke verhoging van het comfort, de snelheid en de productiviteit die nodig zijn om moeilijk bereikbare zones te schilderen.

AIRLESS VERLENGDE PISTOLEN, CLEANSHOT & TIPVERLENGSTUKKEN

	ARTIKELNUMMER	OMSCHRIJVING	EURO	
	287019	25 CM TIPVERLENGSTUK MET RAC X TIPHOUDER	€	97,00
	287020	40 CM TIPVERLENGSTUK MET RAC X TIPHOUDER	€	112,00
	287021	50 CM TIPVERLENGSTUK MET RAC X TIPHOUDER	€	126,00
	287022	75 CM TIPVERLENGSTUK MET RAC X TIPHOUDER	€	140,00
	232121	VAST VERLENGSTUK, HD, 25 CM	€	144,00
	232122	VAST VERLENGSTUK, HD, 50 CM	€	189,00
	232123	VAST VERLENGSTUK, HD, 100 CM	€	215,00
	232124	VAST VERLENGSTUK, HD, 150 CM	€	259,00
	232125	VAST VERLENGSTUK, HD, 200 CM	€	290,00
	287026	CLEANSHOT VERLENGD PISTOOL, 90 CM MET RAC X (517)	€	845,00
	287027	CLEANSHOT VERLENGD PISTOOL 180 CM MET RAC X (517)	€	988,00
	244163	CLEANSHOT VERLENGSTUK, 90 CM	€	215,00
	244164	CLEANSHOT VERLENGSTUK, 180 CM	€	334,00
	287030	CLEANSHOT AFSLUITER/KOP, RAC X (517) (WARTELS)	€	281,00
	248947	OVERSPRAY REDUCTIE SET (LL5321, LL5419, 287030, 243295, 246538)	€	872,00



RAC™ X zitting en dichting enkel te gebruiken met RAC™ X tips en tiphouders. Gebruik de oranje dichting for solventhoudende producten

AIRLESS TIPPAKKINGEN

	ARTIKELNUMMER	OMSCHRIJVING	EURO	
	15A978	RAC X DICHRING (ZWART)	€	8,70
	15E557	RAC X DICHRING, ORANJE (VOOR SOLVENTEN)	€	22,00
	115524	RAC V DICHRING (ZWART)	€	13,00
	108962	RAC IV DICHRING (ZWART)	€	6,00
	222155	RAC IV DICHRING (SCHWARZ, 20X)	€	58,00
	111025	RAC IV DICHRING (GELB)	€	4,60
	224082	RAC IV DICHRING (GELB, 20X)	€	40,00
	15A981	RAC X ZITTING	€	8,70
	195558	RAC V ZITTING	€	8,70
	181603	RAC IV ZITTING	€	14,00
	246453	SATZ, RAC X ZITTING + DICHRING (5X)	€	46,00
	248936	SATZ, RAC X ZITTING + DICHRING ORANJE (VOOR SOLVENTEN 5X)	€	46,00
	243281	SATZ, RAC V ZITTING + DICHRING (5X)	€	46,00
	221176	SATZ, RAC IV ZITTING + DICHRING (5X)	€	85,00
	17P501	ZITTING/DICHRING - STANDARD, ULTRA HANDHELD (X5)	€	46,00
	17P502	ZITTING/DICHRING - OPLOSMIDDEL, ULTRAMAX HANDHELD (X5)	€	46,00



De JetRoller™ van Graco is de perfecte oplossing voor aannemers die op zoek zijn naar een flexibele en lichte tool om hun verflussen met de roller sneller te laten verlopen. De JetRoller combineert de efficiëntie van airless spuiten met de voordelen van een afwerking met een roller in een ontwerp dat overspray vrijwel elimineert.

JETROLLER

ARTIKELNUMMER	OMSCHRIJVING	EURO
24V490	JETROLLERS W/ 0.5M EXTENSIE & INLINE PISTOOL, 18CM FRAME , CLEANSHOT , RAC X TIPHOUDER & 515 TIP	€ 846,00
24V491	JETROLLER EURO, 0.5M EXTENSIE , INLINE PISTOOL, 25CM FRAME, CLEANSHOT, RAC X TIPHOUDER & 721 TIP	€ 846,00
24W128	JETROLLER EURO, 0.5M EXTENSIE , INLINE PISTOOL, 45CM FRAME, CLEANSHOT, RAC X TIPHOUDER & 721 TIP	€ 1272,00
24V492	JETROLLER EURO, 0.5M EXTENSIE , 18CM FRAME, CLEANSHOT, RAC X TIPHOUDER & 515 TIP	€ 675,00
24V493	JETROLLER EURO, 0.5M EXTENSIE , 25CM FRAME, CLEANSHOT, RAC X TIPHOUDER & 721 TIP	€ 675,00
24V829	FRAME JETROLLER, 9"	€ 163,00
24V830	FRAME JETROLLER, 18CM	€ 163,00
24V831	FRAME JETROLLER, 25CM	€ 163,00
24V832	EXTENSIE JETROLLER FRAME	€ 122,00



Voor kleinere klossen, wanneer omstandigheden zoals wind, spuiten onmogelijk maken en een airless afwerkwaliteit niet vereist is, kan de verf eventueel met een roller worden aangebracht.

AIRLESS ROLLERS

AIRLESS ROLLERS + ROLLERKAPPEN

	ARTIKELNUMMER	OMSCHRIJVING	EURO
	244279	HOGEDRUK ROLR; 50 CM STAAF MIT EVENFLOW 23CM KOP, 12MM ROL, BINNENMUREN	€ 434,00
	244281	HOGEDRUK ROLR; 45-90 CM TELESKOP, EVENFLOW 23CM KOP, 12MM ROL, BINNENMUREN	€ 928,00
	245397	HOGEDRUK ROLR; INLINE PISTOOL, 50 CM STAAF, EVENFLOW 23CM KOP, 12MM ROL, BINNENMUREN	€ 984,00
	6880095	HOGEDRUK ROLR; 30 CM STAAF, GEOSPERSE 23 CM KOP, 14MM ROL, BUITENMUREN	€ 1474,00
	6880096	HOGEDRUK ROLR; 45 CM STAAF, GEOSPERSE 23 CM KOP, 14MM ROL, BUITENMUREN	€ 1286,00
	6880097	HOGEDRUK ROLR; 90 CM STAAF, GEOSPERSE 23 CM KOP, 14MM ROL, BUITENMUREN	€ 1372,00
	098085	HOGEDRUK ROLR; 45-90 CM STAAF, GEOSPERSE 23 CM KOP, 20MM ROL, BUITENMUREN	€ 1458,00
	098084	HOGEDRUK ROLR; 90-180 CM STAAF, GEOSPERSE 23 CM KOP, 20MM ROL, BUITENMUREN	€ 1531,00
	107589	ROLLERKAP EVENFLOW+GEOSPERSE 23CM, KAP 10MM, SYNTHETISCH, BINNENMUREN	€ 42,00
	107590	ROLLERKAP EVENFLOW+GEOSPERSE 23CM, KAP 12MM, SYNTHETISCH, BINNENMUREN	€ 42,00
	107591	ROLLERKAP EVENFLOW+GEOSPERSE 23CM, KAP 19MM, SYNTHETISCH, BINNENMUREN	€ 42,00
	186944	ROLLERKAP EVENFLOW+GEOSPERSE 30CM, KAP 12MM, SYNTHETISCH, BINNENMUREN	€ 60,00
	186945	ROLLERKAP EVENFLOW+GEOSPERSE 30CM, KAP 19MM, SYNTHETISCH, BINNENMUREN	€ 61,00
	098205	ROLLERKAP EVENFLOW+GEOSPERSE 23CM, KAP 14MM, SYNTHETISCH, BUITENMUREN	€ 103,00
	098206	ROLLERKAP EVENFLOW+GEOSPERSE 23CM, KAP 20MM, SYNTHETISCH, BUITENMUREN	€ 103,00

AIRLESS ROLLER HEADS & EXTENSIONS

	ARTIKELNUMMER	OMSCHRIJVING	EURO
	244271	EVENFLOW-ROLLERKOP (23 CM) VOOR HD STAVEN	€ 243,00
	244623	EVENFLOW-ROLLERKOP (23 CM) VOOR TELESCOOPSTAVEN	€ 251,00
	240005	GEOSPERSE-ROLLERKOP (23 CM) ZONDER KAP	€ 307,00
	218935	GEOSPERSE-ROLLERKOP (23 CM) ZONDER KAP VOOR TELESCOPISCHE STAAF	€ 243,00
	224268	GEOSPERSE-ROLLERKOP (30 CM) ZONDER KAP VOOR TELESCOPISCHE STAAF	€ 329,00
	218775	TELESCOPISCH ROLLERVERLENGSTUK (45-90 CM) MET 244825	€ 581,00
	218776	TELESCOPISCH ROLLERVERLENGSTUK (90-180 CM) MET 244825	€ 684,00
	218777	TELESCOPISCH ROLLERVERLENGSTUK (180-360 CM) MET 244825	€ 911,00

AIRLESS ROLLER ADAPTERS

	ARTIKELNUMMER	OMSCHRIJVING	EURO
	244825	ADAPTER VOOR 1/4" NAAR 7/8" TELESCOPISCH ROLLERVERLENGSTUK	€ 40,00
	224399	45°WARTELADAPTER 7/8" (I X U)	€ 98,00
	224398	ADAPTER 1/8" TO 7/8" VOOR HD VERLENGING	€ 148,00



OPTIMALE AFWERKKWALITEIT

In een standaard airless systeem passeert de verf 3 filters voorafgaand aan verneveling: inlaatzeef, pompfilter en het pistoolfilter.

Het eerste filter is het grootst, het laatste het kleinst.

AIRLESS AANZUIGFILTERS, PISTOOLFILTERS & POMPFILTERS



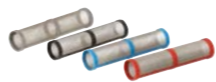
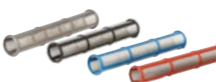

AIRLESS AANZUIGFILTERS

	ARTIKELNUMMER	OMSCHRIJVING		EURO
	106114	AANZUIGFILTER 60 MAASGROOTTE GH ROOF RIGS	€	95,00
	167759	AANZUIGFILTER , EH 433	€	41,00
	181072	AANZUIGFILTER,1", MAASGROOTTE 8, ULTRA(+), MAX / EM5000 / GMAX	€	36,00
	181073	AANZUIGFILTER, 1/2" ULTRA PLUS MAX/EM5000/GMAX	€	37,00
	183770	AANZUIGFILTER, 3/4", MAASGROOTTE 8, 190ES, ST PRO 395/495	€	35,00
	187119	AANZUIGFILTER 1 1/2" GM 1030	€	159,00
	189920	AANZUIGFILTER 1", MAASGROOTTE 8, MARK V.HD,GMAX 5900HD, GMAX 7900	€	50,00
	235004	AANZUIGFILTER 3/4-16UNF., 390ST/490ST/395ST/ 495ST	€	35,00
	237820	AANZUIGFILTER 5/8",290 EASY	€	36,00
	237840	AANZUIGFILTER 1 1/4", GM GMAX 10000, HYDRAMAX	€	90,00
	246385	AANZUIGFILTER 7/8" ST MAX 395/495	€	35,00
	288472	AANZUIGFILTER MAASGROOTTE 10, GH, CRUSH-PROOF	€	98,00
	288481	AANZUIGFILTER MAASGROOTTE 10, GH, CRUSH-PROOF MET SCHROEFDOP	€	159,00
	288480	SCHROEFDOP AANZUIGFILTER	€	147,00
	289131	AANZUIGFILTER MAASGROOTTE 16, GH, CRUSH-PROOF	€	90,00
	289132	AANZUIGFILTER MAASGROOTTE 16, GH, CRUSH-PROOF MET SCHROEFDOP	€	179,00
	15V573	AANZUIGFILTER MAASGROOTTE 10, DUTYMAX, CRUSH-PROOF	€	100,00

AIRLESS POMPFILTERS

	ARTIKELNUMMER	OMSCHRIJVING		EURO
	246425	MATERIAALFILTER, MAASGROOTTE 30, GRIJS	€	30,00
	246384	MATERIAALFILTER, MAASGROOTTE 60, ZWART	€	30,00
	246382	MATERIAALFILTER, MAASGROOTTE 100, BLAUW	€	30,00
	246383	MATERIAALFILTER, MAASGROOTTE 200, ROOD	€	30,00
	243080	MATERIAALFILTER ,MAASGROOTTE 60, EASY-OUT-KORT , ZWART	€	29,00
	243081	MATERIAALFILTER ,MAASGROOTTE 100, EASY-OUT-KORT, BLAUW	€	29,00
	243226	MATERIAALFILTER ,MAASGROOTTE 200, EASY-OUT-KORT, ROOD	€	29,00
	244071	MATERIAALFILTER ,MAASGROOTTE 30, EASY-OUT-LANG, GRIJS	€	36,00
	244067	MATERIAALFILTER ,MAASGROOTTE 60, EASY-OUT-LANG, ZWART	€	36,00
	244068	MATERIAALFILTER ,MAASGROOTTE 100, EASY-OUT-LANG, BLAUW	€	36,00
	244069	MATERIAALFILTER ,MAASGROOTTE 200, EASY-OUT-LANG, ROOD	€	36,00
	257094	MATERIAALFILTER, MAASGROOTTE 40, FINISHPRO 290	€	12,00

AIRLESS PISTOOLFILTERS

	ARTIKELNUMMER	OMSCHRIJVING		EURO
	218131	PISTOOLFILTER, MAASGROOTTE 50 CONTR. + FTX-E(BLAUW)	€	14,00
	218133	PISTOOLFILTER, MAASGROOTTE 100 CONTR. +FTX-E (ORANJE)	€	14,00
	256975	PISTOOLFILTER, MAASGROOTTE 150 CONTR., FTX-E + AA30 (ROT)	€	17,00
	24X383	PISTOOLFILTER, MAASGROOTTE 50 (BLAUW, X25)	€	362,00
	24X695	PISTOOLFILTER, MAASGROOTTE 100 (ORANJE, X25)	€	362,00
	257129	PISTOOLFILTER EASY-OUT, MAASGROOTTE 30 (GRIJS)	€	12,00
	287032	PISTOOLFILTER EASY-OUT, MAASGROOTTE 60 (ZWART)	€	11,00
	19Y355	PISTOOLFILTER COMPACT GUN EASY-OUT, MAASGROOTTE 60 (ZWART)	€	11,00
	287033	PISTOOLFILTER EASY-OUT, MAASGROOTTE 100 (BLAUW)	€	11,00
	19Y356	PISTOOLFILTER COMPACT GUN EASY-OUT, MAASGROOTTE 100 (BLAUW)	€	11,00
	257130	PISTOOLFILTER EASY-OUT, MAASGROOTTE 200 (ROOD)	€	12,00
	19F826	PISTOOLFILTER COMPACT GUN EASY-OUT, MAASGROOTTE 200 (ROOD)	€	11,00
	287034	PISTOOLFILTER EASY-OUT, MAASGROOTTE 60 + 100	€	18,00
	19Y358	PISTOOLFILTER COMPACT GUN EASY-OUT, MAASGROOTTE 60 + 100	€	18,00
	24X696	PISTOOLFILTER EASY-OUT, MAASGROOTTE 60 (ZWART, X25)	€	268,00
	24X697	PISTOOLFILTER EASY-OUT, MAASGROOTTE 100 (BLAUW, X25)	€	268,00
	224455	PISTOOLFILTER, MAASGROOTTE 50, CONTRACTOR, FTX-E (X2)	€	17,00
	224456	PISTOOLFILTER, MAASGROOTTE 100, CONTRACTOR, FTX-E (X2)	€	17,00
	289922	PISTOOLFILTER MAASGROOTTE 18 (X2), MET SCHRAPER , T-MAX	€	104,00
	289923	PISTOOLFILTER MAASGROOTTE 30 (X2), MET SCHRAPER , T-MAX	€	104,00



Pump Armor™ Dubbele functie:

1. Onverdund voor langdurige opslag – smeermiddel en antivries ineen
2. Opgelost in water (20%) voor efficiëntere dagelijkse reiniging

AIRLESS VLOEISTOFFEN



AIRLESS ACCESSOIRES: DIVERS

ARTIKELNUMMER	OMSCHRIJVING	EURO
238049	TSL 118ML	€ 13,00
206994	TSL 250ML	€ 26,00
206995	TSL 1L	€ 102,00
206997	TSL 1L (X12)	€ 1023,00
206996	TSL 3.8L	€ 280,00
206998	TSL 3.8 L (X4)	€ 1019,00
253574	PUMP ARMOR VLOEIBARE BESCHERMING, 1 L	€ 41,00
245133	PUMP ARMOR VLOEIBARE BESCHERMING, 3.8 L	€ 130,00
207428	HYDRAULISCHE VLOEISTOF, 3.8L	€ 87,00
117784	POMPOLIE, 0,133 LITER, UITSLUITEND VOOR RADIAALAXIALE POMPEN (G-FORCE)	€ 44,00
246377	POMPOLIE, 1 LITER, UITSLUITEND VOOR POMPEN MET DRIE PLUNJERS (G-FORCE)	€ 47,00

ARTIKELNUMMER	OMSCHRIJVING	EURO
24Y472	BLISTERVERPAKKING - PROXCHANGE ONDERPOMP GX	€ 163,00
17C489	BLISTERVERPAKKING - PROCONNECT ONDERPOMP (CLASSIC, STMAX, FP)	€ 488,00
19F873	BLISTERVERPAKKING - PROCONNECT ONDERPOMP (ULTRA 490/495 XT)	€ 518,00
17J444	GX DRAAGRIEM	€ 14,00
24B250	MATERIAALTRECHTER, 5,7 LITER, FP290	€ 324,00
17H171	MATERIAALTRECHTER, 5.7L, (GXFF, CLASSIC, STMAX, FP)	€ 243,00
19B968	AIRLESS AFWERKINGSSET - 5.7L MATERIAALHOUDER, FFLP210 TIP, 3/16" X 7.5M SLANG + 1/8" X 0.9M HULPSLANG, 100 MESH MATERIAALFILTER + PISTOOLFILTER	€ 418,00
20B529	MATERIAALTRECHTER, 5.7L, (ULTRA XT)	€ 315,00
287253	TOOL BOX ULTRAMAX II, MARK MAX, ULTRA XT, MARK XT	€ 108,00
240296	SLANGBINDER (4X)	€ 41,00
15F446	PISTOOLGEREEDSCHAP	€ 28,00
70783001001	LAAGDIKTEMETER	€ 16,00
224457	WARTEL 1/4" (204940 IN BLISTERVERPAKKING)	€ 98,00
24W090	PROGUARD 230V, CEE 7/7, SHUKO	€ 144,00
24W755	PROGUARD 230V, IEC320, MULTI-CORD	€ 142,00
24V145	MODULAIRE QUICKREEL-SET (ULTRA 695/795/1095 XT & MARK V XT)	€ 840,00
25V146	MODULAIRE QUICKREEL-SET (MARK VII XT)	€ 840,00
289535	VOCHTAFSCHEIDER	€ 182,00
119799	REINIGINGSBORSTEL	€ 8,70
17Y297	CONTRACTOR PC PROCONNECT VERVANGENDE CARTRIDGE	€ 100,00
2005788	CONTRACTOR POWERSHOT PROCONNECT VERVANGENDE CARTRIDGE	€ 117,00
20A163	DEWALT® 54V 6.0 AH FLEXVOLT-ACCU	€ 479,00
20A166	DEWALT® VENTILATORGEKOELDE SNELLADER	€ 308,00



Gebruik de aanzuigkit voor verfhouders/containers om rechtstreeks te pompen vanuit een 500 of 1.000 litercontainer van uw materiaalleverancier: bijzonder effectief, met name bij inbouw in een bestelwagen of aanhangwagen.

AIRLESS AANZUIGSETS

ARTIKELNUMMER	OMSCHRIJVING	EURO
246386	30L AANZUIGSET, 3/4" SLANG, POMPZIJDE 1 1/4", FILTER (STMAX)	€ 352,00
248216	30L AANZUIGSET, 1" SLANG, POMPZIJDE 1 5/16" (UMII, GMAX)	€ 611,00
248390	20-200L AANZUIGSET, 1"X1M SLANG, POMPZIJDE 1 5/16" (UMII, GMAX)	€ 862,00
287541	200L AANZUIGSET, 1"X1.5M SLANG, POMPZIJDE 1 5/16", ONTLUCHTINGSSLANG (UMII, GMAX)	€ 1005,00
289669	200L AANZUIGSET, 1"X1.5M SLANG, POMPZIJDE 1" NIEUW ONDERDEEL, ONTLUCHTINGSSLANG (MARK VII/X, GMAX II 7900HD, DUTYMAX)	€ 975,00
098265	CONTAINER AANZUIGSET, 3/4"X1.8M SLANG, POMPZIJDE 3/4", DIN C KOPPELING (UM)	€ 862,00
24M445	CONTAINER AANZUIGSET, 2"X0.6M SLANG, POMPZIJDE 1", DIN C KOPPELING (UMII, MARK, GMAX, DUTYMAX)	€ 951,00
25D091	CONTAINER AANZUIGSET, 2"X0.6M SLANG, CAM KOPPELING (UMII, MARK, GMAX, DUTYMAX)	€ 305,00
17Y659	CONTAINER AANZUIGSET, OPLOSMIDDEL, 2"X0.6M SLANG, CAM KOPPELING (UMII, MARK, GMAX, DUTYMAX)	€ 435,00
287936	200L AANZUIGSET, 2"X2M SLANG, POMPZIJDE CAM 1 1/2", FILTER (GH1017/2570/5040/833)	€ 1718,00
245468	200L AANZUIGSET, 1 1/4"X2M SLANG, POMPZIJDE 1 1/4" (GH733)	€ 975,00
16V063	200L AANZUIGSET, 1"X1.8M SLANG, POMPZIJDE DIXON KOPPELING (GH733)	€ 884,00
287916	200L AANZUIGSET, 1 1/2"X2M SLANG, POMPZIJDE 1 1/2", FILTER (GH833)	€ 1100,00
287915	200L AANZUIGSET, 1 1/2"X2M SLANG, POMPZIJDE 1 1/2", FILTER (GH833)	€ 1553,00



Eenvoudig omschakelen naar een benzine- of elektromotorkit is snel te realiseren op de werkvloer – door één persoon en zonder gereedschap.

AIRLESS KIT VOOR MOTOR

ARTIKELNUMMER	OMSCHRIJVING	EURO
248943	HONDA GX 160 - 5,5 PK (4,1 KW)	€ 1456,00
248944	HONDA GX 200 - 6,5 PK (4,8 KW)	€ 1559,00
248945	HONDA GX 270 - 9 PK (6,6 KW)	€ 2202,00
248946	GH ELEKTRISCHE MOTOR- 3 PK (2,2 KW)	€ 2567,00
24M669	DUTYMAX ELECTRISCHE MOTOR, 7.3 PK	€ 3426,00



Endurance™ Vortex MaxLife en MaxLife Extreme™:
De meest duurzame pompen ooit gebouwd.

AIRLESS PROCONNECT XT PUMP LOWERS (VORTEX / MAXFLO 2)

PART NUMBER	DESCRIPTION	EURO
2001548	ULTRA 695 XT STANDARD - VORTEX ONDERPOMP - MAXFLO 2	€ 863,00
2001549	ULTRA 695 XT PROCONTRACTOR - VORTEX ONDERPOMP - MAXFLO 2 - MAXLIFE	€ 1566,00
2001573	ULTRA 795 XT STANDARD - VORTEX ONDERPOMP - MAXFLO 2	€ 863,00
2001574	ULTRA 795 XT PROCONTRACTOR - VORTEX ONDERPOMP - MAXFLO 2 - MAXLIFE	€ 1566,00
2001550	ULTRA 1095 XT STANDARD - VORTEX ONDERPOMP - MAXFLO 2	€ 1103,00
2001551	ULTRA 1095 XT PROCONTRACTOR - VORTEX ONDERPOMP - MAXFLO 2 - MAXLIFE EXTREME	€ 2310,00
2001554	MARK V XT STANDARD - VORTEX ONDERPOMP - MAXFLO 2	€ 1464,00
2001555	MARK V XT PROCONTRACTOR - VORTEX ONDERPOMP - MAXFLO 2 - MAXLIFE EXTREME	€ 2720,00
2001556	MARK VII XT STANDARD - VORTEX ONDERPOMP - MAXFLO 2	€ 1750,00
2001557	MARK VII XT PROCONTRACTOR - VORTEX ONDERPOMP - MAXFLO 2 - MAXLIFE EXTREME	€ 2798,00

AIRLESS VORTEX XT PUMP RODS

PART NUMBER	DESCRIPTION	EURO
2001537	ULTRA XT 695/795 STANDARD - VORTEX ZUIGERSTAND	€ 308,00
2001538	ULTRA XT 695/795 PROCONTRACTOR - VORTEX ZUIGERSTAND - MAXLIFE	€ 718,00
2001539	ULTRA XT 1095 STANDARD - VORTEX ZUIGERSTAND	€ 435,00
2001540	ULTRA XT 1095 PROCONTRACTOR - VORTEX ZUIGERSTAND - MAXLIFE EXTREME	€ 950,00
2001544	MARK V XT STANDARD - VORTEX ZUIGERSTAND	€ 622,00
2001545	MARK V XT PROCONTRACTOR - VORTEX ZUIGERSTAND - MAXLIFE EXTREME	€ 1085,00
2001546	MARK VII XT STANDARD - VORTEX ZUIGERSTAND	€ 622,00
2001547	MARK VII XT PROCONTRACTOR - VORTEX ZUIGERSTAND - MAXLIFE EXTREME	€ 1085,00



Endurance™ Vortex MaxLife en MaxLife Extreme™:
De meest duurzame pompen ooit gebouwd.

AIRLESS PROCONNECT ONDERPOMPEN (VORTEX / MAXFLO 2) & ZUIGERSTANGEN

AIRLESS PROCONNECT ONDERPOMPEN (VORTEX / MAXFLO 2)

ARTIKELNUMMER	OMSCHRIJVING	EURO
17H823	ULTRA MAX II 695/795 PROCONTRACTOR & GMAX II 3900 PROCONTRACTOR - VORTEX ONDERPOMP - MAXLIFE	€ 1566,00
17H824	ULTRA MAX II 1095 PROCONTRACTOR & GMAX II 5900 PROCONTRACTOR - VORTEX ONDERPOMP - MAXLIFE	€ 1959,00
17H826	ULTRA MAX II 1095 IRONMAN & GMAX II 5900 IRONMAN - VORTEX ONDERPOMP - MAXLIFE EXTREME	€ 2310,00
17H832	MARK IV PROCONTRACTOR - VORTEX ONDERPOMP - MAXFLO 2 - MAXLIFE	€ 2100,00
17H833	MARK V PROCONTRACTOR & GMAX II 5900 HD PROCONTRACTOR - VORTEX ONDERPOMP - MAXFLO 2 - MAXLIFE	€ 2462,00
17H834	MARK VII PROCONTRACTOR - VORTEX ONDERPOMP - MAXFLO 2 - MAXLIFE	€ 2760,00
17H835	MARK X PROCONTRACTOR & GMAX II 7900 HD PROCONTRACTOR - VORTEX ONDERPOMP - MAXFLO 2 - MAXLIFE	€ 2989,00
17H825	GMAX II 7900 PROCONTRACTOR - VORTEX ONDERPOMP - MAXLIFE	€ 2330,00
17H836	MARK V IRONMAN - VORTEX ONDERPOMP - MAXFLO 2 - MAXLIFE EXTREME	€ 2720,00
17H892	MARK VII IRONMAN - VORTEX ONDERPOMP - MAXFLO 2 - MAXLIFE EXTREME	€ 2798,00
17H837	MARK X IRONMAN & GMAX II 7900 HD IRON MAN - VORTEX ONDERPOMP - MAXFLO 2 - MAXLIFE EXTREME	€ 3314,00
17H827	GMAX II 7900 IRONMAN - VORTEX ONDERPOMP - MAXFLO 2 - MAXLIFE EXTREME	€ 2925,00
17H828	MARK IV STANDARD - ONDERPOMP - MAXFLO 2	€ 1264,00
17H829	MARK V STANDARD & GMAX II 5900 HD STANDARD - ONDERPOMP - MAXFLO 2	€ 1464,00
17H830	MARK VII STANDARD - ONDERPOMP - MAXFLO 2	€ 1750,00
17H831	MARK X STANDARD - ONDERPOMP - MAXFLO 2	€ 1919,00
25E689	GMAX II 7900 HD STANDARD - ONDERPOMP - MAXLIFE - MAXFLO 2	€ 2130,00

AIRLESS MAXLIFE VORTEX ZUIGERSTANGEN

ARTIKELNUMMER	OMSCHRIJVING	EURO
17H876	MAXLIFE VORTEX ZUIGERSTANG, ULTRA MAX II 695/795 PROCONTRACTOR & GMAX II 3900 PROCONTRACTOR	€ 718,00
17H877	MAXLIFE VORTEX ZUIGERSTANG, ULTRA MAX II 1095 PROCONTRACTOR & GMAX II 5900 PROCONTRACTOR	€ 906,00
17H879	MAXLIFE EXTREME VORTEX ZUIGERSTANG, ULTRA MAX II 1095 IRONMAN & GMAX II 5900 IRONMAN	€ 1122,00
17H880	MAXLIFE EXTREME VORTEX ZUIGERSTANG, GMAX II 7900 IRONMAN	€ 1257,00
17H881	MAXLIFE VORTEX ZUIGERSTANG, MARK IV PROCONTRACTOR	€ 924,00
17H882	MAXLIFE VORTEX ZUIGERSTANG, MARK V PROCONTRACTOR & MARK VII PROCONTRACTOR & G-MAX II 5900 HD PROCONTRACTOR	€ 952,00
17H883	MAXLIFE VORTEX ZUIGERSTANG, MARK X PROCONTRACTOR & G-MAX II 7900 HD PROCONTRACTOR	€ 1013,00
17H878	MAXLIFE VORTEX ZUIGERSTANG, GMAX II 7900 PROCONTRACTOR	€ 917,00
17H884	MAXLIFE EXTREME VORTEX ZUIGERSTANG, MARK V IRONMAN & MARK VII IRONMAN	€ 1085,00
17H885	MAXLIFE EXTREME VORTEX ZUIGERSTANG, MARK X IRONMAN	€ 1324,00



QUIKPAKS

ARTIKELNUMMER	OMSCHRIJVING	EURO
17H838	ULTRA MAX II 695/795 STANDARD/PREMIUM, ULTRA MAX II 695 STANDARD, ULTRA MAX 795, GMAX II 3900 STANDARD, GMAX II 3900 PROCONTRACTOR, GMAX II 3900 STANDARD/PREMIUM, GMAX 3900, LINELAZER 3900	€ 167,00
17H841	ULTRA MAX II 695/795 PROCONTRACTOR	€ 167,00
17H839	ULTRA MAX II 1095 STANDARD/PREMIUM, GMAX II 5900 STANDARD, GMAX II 5900 HD PREMIUM, GMAX 5900, LINELAZER 5900	€ 197,00
17H842	ULTRA MAX II 1095 PROCONTRACTOR SERIES, GMAX II 5900 PROCONTRACTOR	€ 197,00
17H843	ULTRA MAX II 1095 IRONMAN, GMAX II 5900 IRONMAN	€ 342,00
17H845	MARK IV STANDARD	€ 276,00
17H849	MARK IV PROCONTRACTOR	€ 318,00
17H846	MARK V STANDARD, GMAX 5900 HD STANDARD	€ 298,00
17H850	MARK V PROCONTRACTOR/IRONMAN, GMAX II 5900 HD PROCONTRACTOR/IRONMAN	€ 342,00
17H847	MARK VII STANDARD	€ 301,00
17H851	MARK VII PROCONTRACTOR/IRONMAN	€ 329,00
17H848	MARK X STANDARD	€ 356,00
17H852	MARK X PROCONTRACTOR/IRONMAN, GMAX II 7900 HD STANDARD/PROCONTRACTOR/IRONMAN	€ 384,00
17H840	GMAX II 7900 STANDARD, GMAX II 7900 PROCONTRACTOR	€ 318,00
17H844	GMAX II 7900 IRONMAN	€ 435,00





PROCONNECT
De pomp is te verwijderen, te installeren en af te stellen zonder gereedschap.
=> Ter plekke!
=> In slechts enkele seconden!

AIRLESS PROCONNECT-ONDERPOMPEN, MAXLIFE-ONDERPOMPEN EN -STANGEN

AIRLESS PROCONNECT-ONDERPOMPEN

ARTIKELNUMMER	OMSCHRIJVING	EURO
248204	ULTRA MAX II 695/795 STANDARD - ONDERPOMP	€ 1010,00
248205	ULTRA MAX II 1095 STANDARD - ONDERPOMP	€ 1365,00
16X414	ULTRA MAX II 695/795 & GMAX II 3900 PROCONTRACTOR - ONDERPOMP - PROCONNECT 2	€ 911,00
16X419	ULTRA MAX II 1095 & GMAX II 5900 PROCONTRACTOR - ONDERPOMP - PROCONNECT 2	€ 1253,00
16X420	ULTRA MAX II 1095 & GMAX II 5900 IRONMAN - ONDERPOMP - PROCONNECT 2 - MAXLIFE	€ 1977,00
16X428	MARK IV STANDARD - ONDERPOMP	€ 1231,00
16X429	MARK V STANDARD & GMAX II 5900 HD STANDARD - ONDERPOMP	€ 1623,00
16Y601	MARK VII STANDARD - ONDERPOMP	€ 1789,00
16X425	MARK X STANDARD & GMAX II 7900 HD STANDARD - ONDERPOMP - MAXLIFE	€ 2325,00
16X418	MARK IV PROCONTRACTOR - ONDERPOMP - PROCONNECT 2	€ 1443,00
16X421	MARK V & GMAX II 5900 HD PROCONTRACTOR - ONDERPOMP - PROCONNECT 2	€ 1617,00
16Y602	MARK VII PROCONTRACTOR - ONDERPOMP - PROCONNECT 2	€ 1889,00
16X427	MARK X PROCONTRACTOR & GMAX II 7900 HD PROCONTRACTOR/IRONMAN - ONDERPOMP - PROCONNECT 2 - MAXLIFE	€ 2367,00
16Y599	MARK V IRONMAN - ONDERPOMP - PROCONNECT 2 - MAXLIFE	€ 1965,00
16Y598	GMAX II 3900 STANDARD - ONDERPOMP	€ 863,00
16Y706	GMAX II 5900 STANDARD - ONDERPOMP	€ 1103,00
16X423	GMAX II 7900 STANDARD - ONDERPOMP - MAXLIFE	€ 2223,00
16X426	GMAX II 7900 PROCONTRACTOR - ONDERPOMP - PROCONNECT 2 - MAXLIFE	€ 2369,00
288467	GH200 - ONDERPOMP, PROCONNECT	€ 2357,00
288468	GH230/300 - ONDERPOMP, PROCONNECT	€ 2357,00

ARTIKELNUMMER	OMSCHRIJVING	EURO
17R044	APX 6200 ONDERPOMP, CHROME	€ 1687,00
17R042	APX 8200 ONDERPOMP, CHROME	€ 1794,00
24W999	DUTYMAX - ONDERPOMP, STANDARD	€ 2101,00
24X001	DUTYMAX - ONDERPOMP, PROCONTRACTOR	€ 2589,00
16U755	GH 933 - ONDERPOMP	€ 4390,00
16U751	GH 1017 - ONDERPOMP	€ 10694,00
16U752	GH 2570 - ONDERPOMP	€ 8350,00
16U754	GH 5040 - ONDERPOMP	€ 4535,00

AIRLESS MAXLIFE-ONDERPOMPEN EN -STANGEN

ARTIKELNUMMER	OMSCHRIJVING	EURO
17H864	MAXLIFE POMPCILINDER, ULTRA MAX II 695/795 PROCONTRACTOR & MARK IV PROCONTRACTOR & GMAX II 3900 PROCONTRACTOR	€ 509,00
257031	MAXLIFE POMPCILINDER, ULTRA MAX II 1095 PROCONTRACTOR/IRONMAN, MARK V/VII PROCONTRACTOR/IRONMAN & GMAX II 5900 PROCONTRACTOR/IRONMAN	€ 524,00
249121	MAXLIFE POMPCILINDER, MARK X STANDARD/PROCONTRACTOR/IRONMAN, GMAX 7900 (HD) STANDARD/PROCONTRACTOR/IRONMAN	€ 626,00
287817	MAXLIFE POMPCILINDER (GH230/300)	€ 784,00
249119	MAXLIFE ZUIGERSTANG EH/GH200	€ 601,00
287816	MAXLIFE ZUIGERSTANG GH 230,300	€ 940,00
287832	MAXLIFE ZUIGERSTANG GH833	€ 1328,00
288469	MAXLIFE ZUIGERSTANG (GH200)	€ 692,00
288470	MAXLIFE ZUIGERSTANG (GH230/300)	€ 698,00



PISTOLEN & APPLICATOREN VOOR TEXSPRAY

ARTIKELNUMMER	OMSCHRIJVING	EURO
289605	HD BLUE PLASTER PISTOOL, RAC X TIPHOUDER, 531 TIP	€ 712,00
245820	HD INLINE PLASTER PISTOOL	€ 1000,00
245924	PISTOOL MET MATERIAALHOUDER COMPLEET (INHOUD 5.5 LITER)	€ 299,00
24S155	RTX PISTOOL ZONDER ONTLASTING	€ 961,00
256383	LANS T-MAX 506/657	€ 1268,00
17Z054	LANS T-MAX 1" CAM (M), RAC X	€ 1162,00
17Z128	FREE FLO LANS T-MAX 1" CAM (M), RONDE LUCHTSPIJKOP, FINE-FINISH-SET	€ 1436,00
17Y910	STX GUN 1" CAM (M)*	€ 2537,00
24B944	FLEXHEAD VERLENGPISTOOL 1" CAM (M), 1M, ZONDER KOGELVENTIEL (24C414)	€ 1450,00
17Y907	HD INLINE PLASTER PISTOOL, 1" CAM	€ 998,00
24C414	KOGELVENTIEL, 1" CAM MXF (17Z128, 24B944, 24B945)	€ 635,00
244052	ACCESSOIRES SET VOOR LUCHTVERNEVELAAR, MET SLANG	€ 1036,00
244223	ACCESSOIRESSET ,LUCHTATOMISATIE ZONDER SLANG	€ 806,00
289611	HD BLUE PLASTER PISTOOL, RAC X (427,531), 3/8"X15M + HULPSLANG 1/4"X0.9M	€ 1089,00
18H255	KIT, ACCESSOIRE, LUCHTATOMISATIE MET WIDETEX™	€ 896,00
289585	1/2" SLANG + TEXTURE PISTOOL	€ 2617,00
24S135	RTX5500 HEAVY-DUTY-SPIJKPISTOOL	€ 1031,00



Zorg steeds voor een aangepaste spuitkop voor ieder materiaal



LUCHTSPIJKOPPEN VOOR TEXSPRAY

ARTIKELNUMMER	OMSCHRIJVING	EURO
234153	TEXSPRAY LUCHTSPIJKPEN (SET WIT 6 MM/ GRIJS 8 MM / ZWART 12 MM)	€ 67,00
234538	TEXSPRAY SPIJKOP FIJN BEIGE	€ 46,00
234277	TEXSPRAY SPIJKOP SMAL WIT	€ 46,00
234278	TEXSPRAY SPIJKOP MEDIUM GRIJS	€ 46,00
234279	TEXSPRAY SPIJKOP LARGE ZWART	€ 46,00
15C883	3MM RONDE LUCHTSPIJKOP	€ 96,00
15C884	4MM RONDE LUCHTSPIJKOP	€ 96,00
15C885	6MM RONDE LUCHTSPIJKOP	€ 96,00
15C886	8MM RONDE LUCHTSPIJKOP	€ 96,00
15C887	10MM RONDE LUCHTSPIJKOP	€ 96,00
15C888	12MM RONDE LUCHTSPIJKOP	€ 96,00
248888	3MM RONDE LUCHTSPIJKOP	€ 96,00
248524	4MM RONDE LUCHTSPIJKOP	€ 96,00
248525	6MM RONDE LUCHTSPIJKOP	€ 96,00
248526	8MM RONDE LUCHTSPIJKOP	€ 96,00
248527	10MM RONDE LUCHTSPIJKOP	€ 96,00
24S142	WIDETEX SET	€ 105,00
24S143	WIDETEX SET, GEHARD	€ 335,00
287227	FINE-FINISH-SET + FF-SCHIJVEN	€ 147,00
18A649	NOZZLES GLUE KIT, 6+12 MM	€ 301,00
18A652	NOZZLE GLUE, 6MM	€ 151,00
18A653	NOZZLE GLUE, 12MM	€ 151,00
17Z635	WIDETEX FF SET (STX)	€ 247,00
18A155	WIDETEX FF SET, GEHARD (LANCE, FREEFLO)	€ 247,00



OPTIMALE PRODUCTIVITEIT– Voedt de pomp dmv zwaartekracht.
Zeer nuttig bij het gebruik van dikke materialen zoals gips en pleister. Dankzij de grote capaciteit kan langer worden doorgewerkt zonder bijvullen.

ACCESSOIRES TEXSPRAY

ARTIKELNUMMER	OMSCHRIJVING	EURO
 287987	MATERIAALCONTAINER VOOR VERF EN PLEISTER	€ 1057,00
17P196	VIBRA-FLO MATERIAALCONTAINER VOOR VERF EN PLEISTER, 230V EU	€ 1867,00
17P002	VIBRA-FLO MATERIAALCONTAINER VOOR VERF EN PLEISTER, 230V IT, DK, CH	€ 1829,00
289587	ZAKKENPERSSYSTEEM (MATERIAALCONTAINER 287987, 17P196, 17P002)	€ 917,00
289823	ZAKKENPERSSYSTEEM (T-MAX 506/657 - JAAR -2019)	€ 1161,00
17Z539	ZAKKENPERSSYSTEEM (T-MAX 506/657/6912 - JAAR 2019+)	€ 1162,00
17R172	APX ZAKKENPERSSYSTEEM (APX)	€ 1553,00
17Z186	APX ZAKKENPERSSYSTEEM (T-MAX 506/657/6912 - JAAR 2019+)	€ 1593,00
17R174	APX ZAKKENPERSSYSTEEM (SERVICE MATERIAALRECHTER 287987)	€ 1867,00
 289922	PISTOOLFILTER MAASGROOTTE 18 (X2), MET SCHRAPER , T-MAX	€ 104,00
 289923	PISTOOLFILTER MAASGROOTTE 30 (X2), MET SCHRAPER , T-MAX	€ 104,00
277789	SCHRAPER PISTOOLFILTER T-MAX	€ 13,00
15U047	ZEEF HOPPER	€ 65,00
121543	SCHRAPER DUNPLEISTER	€ 26,00
248515	REINIGINGSSPONSSEN 1" (X5)	€ 96,00
 287314	ROTOFLEX POMPSLANG, SET	€ 180,00
287328	AANSLUITSET EXTERNE COMPRESSOR	€ 1093,00
 17R720	X-FLO SLANGHASPEL (APX)	€ 778,00

PART NUMBER	DESCRIPTION	EURO
 25D491	FASTFINISH COMPRESSOR, 230V EU, IT, DK, CH, UK	€ 1485,00
 25D497	G-TEX GRAVITY-FED PISTOOL	€ 265,00
 25D496	FASTFINISH PISTOOL MET MATERIAALHOUDER ONDER DRUK	€ 326,00
 26A563	LUCHTSLANG 3/8" X 15M	€ 70,00
17Z185	LUCHTVERSTUUVINGSKIT VOOR T-MAX LANS MET LUCHTSPIJTKOPPEN	€ 711,00
17Z144	VERLENGING VOOR POMPSCHAKELAAR + LUCHTSLANG 13M	€ 930,00
 17Z148	VERLENGING VOOR POMPSCHAKELAAR + LUCHTSLANG 18M	€ 1019,00
17Z151	VERLENGING VOOR POMPSCHAKELAAR + LUCHTSLANG 33M	€ 1382,00
17Z303	LUCHTSLANG 3/8" X 13M	€ 219,00
17Z304	LUCHTSLANG 3/8" X 18M	€ 288,00
17Z305	LUCHTSLANG 3/8" X 33M	€ 438,00
17Z157	POMPSCHAKELAAR, 18M	€ 432,00
 18A682	POMPSCHAKELAAR, 0,25M	€ 310,00
17Z158	POMPSCHAKELAAR, 33M	€ 643,00
 15Y525	VERLENGING VOOR POMPSCHAKELAAR, 15M	€ 361,00
17Y905	ONTLUCHTINGSSET T-MAX, 1" CAM	€ 726,00
17Z414	VIBRA-FLO KIT (T-MAX)	€ 1382,00



Ontdek de eerste batterij-aangedreven snoerloze laadpomp.
De pomp is ontworpen om alle handmatige of automatische taping- en afwerkingsgereedschappen gemakkelijk te vullen.
Haal het beste uit uw apparatuur met behulp van onderstaande accessoires.

POWERFILL

ARTIKELNUMMER	OMSCHRIJVING	EURO
18D159	35 CM HI-RISE-VULBUIS COMPLETE SET (INCLUSIEF PRO-UITLAAT EN BOXVULLER)	€ 272,00
18D160	58 CM HI-RISE-VULBUIS COMPLETE SET (INCLUSIEF PRO-UITLAAT EN BOXVULLER)	€ 308,00
18D164	35 CM HI-RISE-VULBUIS EN BOXVULSET (EXCLUSIEF PRO-UITLAAT)	€ 205,00
18D165	58 CM HI-RISE-VULBUIS EN BOXVULSET (EXCLUSIEF PRO-UITLAAT)	€ 240,00
18D161	TAPER-ZWANENHALS-VULBUIS COMPLETE SET (19 L, INCLUSIEF PRO-UITLAAT)	€ 323,00
18D162	XL TAPER-ZWANENHALS-VULBUIS COMPLETE SET (115 L, INCLUSIEF PRO-UITLAAT, ALLEEN PRO XL-VERSIE)	€ 349,00
18D086	SET MET ALLEEN TAPER-ZWANENHALS-VULBUIS (19 L, EXCLUSIEF PRO-UITLAAT)	€ 252,00
18D103	SET MET ALLEEN XL TAPER-ZWANENHALS-VULBUIS (115 L, EXCLUSIEF PRO-UITLAAT, ALLEEN PRO XL-VERSIE)	€ 281,00
18D168	STANDAARD HORIZONTALE UITLAAT MET BOXVULLER	€ 124,00
18D169	BOXVULLERSET	€ 61,00
18D163	PRO-UITLAAT-KNIESTUKSET (VEREIST OM DE HI-RISE-BUIS EN ZWANENHALS TE MONTEREN)	€ 76,00
18D166	XL-POMPOMBOUWSET (INCLUSIEF XL VERSTELBARE VOET, XL-POMPCILINDERBEHUIZING EN POMPSTANG MET BOVENZUIGER)	€ 561,00
18D167	REINIGINGSSLANG SPOELSET (INCLUSIEF UITLAATFITTING, SLANG, 2 REINIGINGSKOGELS)	€ 184,00
248515	SPONSBAL SCHOONMAAKSET (5 STUKS, 30 MM)	€ 96,00
18D170	INLAATFILTERSET, 10 MESH	€ 20,00
17P560	DEWALT® 18V MAX-LITHIUMIONLADER*	€ 172,00
17P557	DEWALT® 18V 2.0 AH MAX-LITHIUMIONBATTERIJ	€ 195,00





Het nieuwe modulaire platform van T-Max laat u toe om uw eigen pomp, materiaaltrechter en accessoires te selecteren. Of u kiest een configuratie die Graco heeft samengesteld. (zie pagina 20/21 voor meer details)

TEXTURE T-MAX MODULES

PART NUMBER	DESCRIPTION	EURO
17Z169	T-MAX 506 PUMPMODULE, 230V EU	€ 5530,00
17Z291	T-MAX 506 PUMPMODULE, 230V IT, DK, CH	€ 5530,00
17Z170	T-MAX 506 PUMPMODULE, 110V UK	€ 5530,00
17Z171	T-MAX 657 PUMPMODULE, 230V EU	€ 6221,00
17Z292	T-MAX 657 PUMPMODULE, 230V IT, DK, CH	€ 6221,00
17Z172	T-MAX 657 PUMPMODULE, 110V UK	€ 6221,00
17Z173	T-MAX 6912 PUMPMODULE, 230V EU	€ 8048,00
17Z293	T-MAX 6912 PUMPMODULE, 230V IT, DK, CH	€ 8048,00
17Z174	T-MAX 6912 PUMPMODULE, 110V UK	€ 8048,00
17Z182	T-MAX MODULE MET MATERIAALTRECHTER (4 ZAKKEN)	€ 1964,00
17Z183	T-MAX MODULE MET MATERIAALTRECHTER (6 ZAKKEN)	€ 2176,00



Maak kennis met Graco's complete lijn van professionele afstrijkmesen. Deze messen zijn ontworpen voor het afwerken van gipsplaten en gips en leveren een snelle en gladde afwerking met minimaal afval of schuren. Ervaar zelf de meest comfortabele manier om de afwerking te doen.

TEXTURE PLEISTERMESSEN

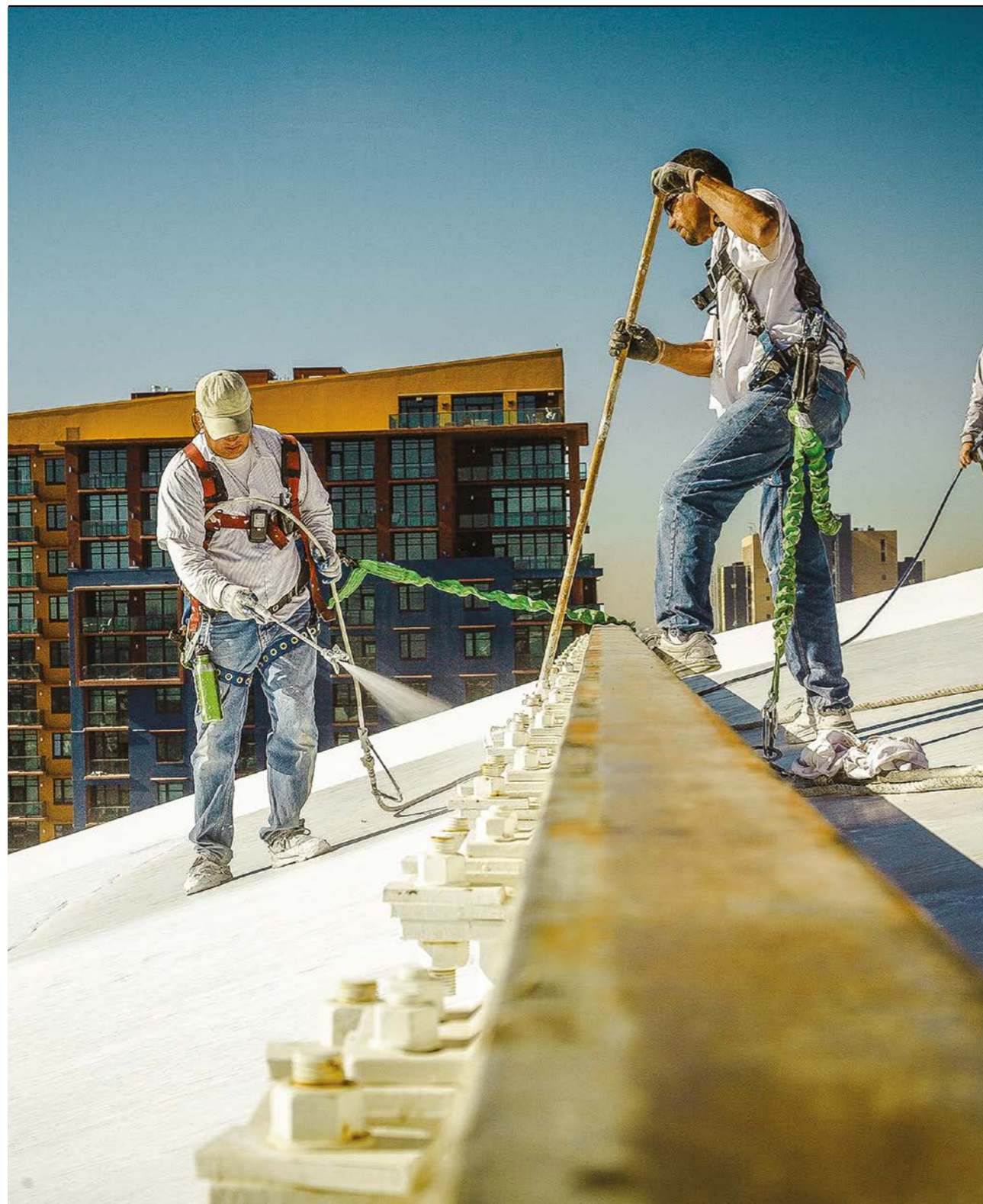

PART NUMBER	DESCRIPTION	EURO
18C676	GIPSPLAATSET (DK42) MET DRAAGBARE CASE, AFSTRIJKMES 25CM, 35CM, 45CM, 60CM, PLAMUURMES 10CM, 15CM, UITSCHUIFBARE VERLENGSTANG 100CM	€ 334,00
18C677	AFSTRIJKSET (SK60) MET DRAAGBARE CASE, AFSTRIJKMES 25CM, 35CM, 45CM, 60CM, 80CM, 100CM, UITSCHUIFBARE VERLENGSTANG 200CM	€ 495,00
18C680	PLAMUURMES - K10, 10CM (4")	€ 19,00
18C681	PLAMUURMES - K15+, 15CM (6")	€ 32,00
18C682	AFSTRIJKMES - B15, 15CM (6")	€ 32,00
18C683	AFSTRIJKMES - B25, 25CM (10")	€ 45,00
18C684	AFSTRIJKMES - B35, 35CM (14")	€ 58,00
18C685	AFSTRIJKMES - B45, 45CM (18")	€ 65,00
18C686	AFSTRIJKMES - B60, 60CM (24")	€ 89,00
18C687	AFSTRIJKMES - B80, 80CM (32")	€ 123,00
18C688	AFSTRIJKMES - B100, 100CM (40")	€ 154,00
18C678	VERLENGSTUK - E100, 50-100CM (20-40")	€ 78,00
18C679	VERLENGSTUK - E200, 100-200CM (40-80")	€ 103,00



Verhoog de efficiëntie van uw werkzaamheden in de heavy duty markt met een selectie van Heavy Duty accessoires waar hoge druk, langere slanglengtes en verhoogde productiviteit u helpen om uit te blinken in uw werkzaamheden.



ACCESSOIRES PROFESSIONELE REINIGING

ARTIKELNUMMER	OMSCHRIJVING	EURO
 25D229	500 BAR ROOFING JETROLLER, 1M EXTENSIE & XHF PISTOOL 3/8", AANPASBAAR 22,5-45CM FRAME, XHD TIPHOUDER & XHD935+939	€ 2211,00
25D227	XTR7 HIGH FLOW PISTOOL, XHD (429,527,531), 1/2"X15M + HULPSLANG 3/8"X3M - 500 BAR	€ 2210,00
25D228	XTR7 HIGH FLOW PISTOOL, 0,5M EXTENSIE, XHD (429,527,531), 1/2"X15M (3X) + HULPSLANG 3/8"X3M - 500 BAR	€ 5557,00
16U757	HD BLUE PLASTER PISTOOL, 0,75M EXTENSIE, RAC X (519,531), 1/2"X15M (5X) + HULPSLANG 3/8"X3M - 276 BAR	€ 5336,00
16U759	FLEX PLUS PISTOOL, 0,5M EXTENSIE, XHD (517,531), 1/2"X15M (5X) + HULPSLANG 3/8"X3M + HULPSLANG 1/4"X0,9M - 276 BAR	€ 7315,00
16V015	XTR7 PISTOOL, XHD (519), 3/8"X15M + HULPSLANG 1/4"X1,8M - 500 BAR	€ 1527,00
16U761	XTR7 PISTOOL, 0,5M EXTENSIE, XHD (519,531), 3/4"X15M (4X) + HULPSLANG 1/2"X15M + HULPSLANG 1/4"X3M - 500 BAR	€ 26670,00
17B825	XHF PISTOOL, 0,5M EXTENSIE, XHD (429,531), 3/4"X15M (4X) + HULPSLANG 1/2"X15M + HULPSLANG 1/4"X3M - 500 BAR	€ 26670,00
 25D078	MATERIAALCONTAINER, 2" CAM CONNECTIE, 2"X 0,5M AANZUIGSLANG (DUTYMAX 675, GH933/733/1017/2570/5040)	€ 1450,00
16U505	ROESTVRIJ STALEN MATERIAALCONTAINER KIT (GH733,933,5040)	€ 2511,00
17U148	HD EXTENSIE 1M, 500 BAR	€ 504,00
25D091	SUCTION HOSE CAM LOCK, WATERBORN	€ 305,00
 17Y659	SUCTION HOSE CAM LOCK, SOLVENT	€ 435,00

PRIJSLIJST IN EURO

Uw projectbehoefte vertaald in de G-Force II hogedrukreinigers van Graco. Van occasionele tot vaak voorkomende en langdurige klussen, onze direct aangedreven en riemaangedreven hogedrukreinigers kunnen alles aan.

REINIGING

G-FORCE II

ARTIKELNUMMER	OMSCHRIJVING	EURO
244785	G-FORCE-PISTOOL ALLEEN (345 BAR)	€ 95,00
244779	G-FORCE-PISTOOL 50 CM (345 BAR)	€ 151,00
127469	G-FORCE-PISTOOL 91 CM (SCHROEFDRAAD) (220 BAR)	€ 79,00
244784	G-FORCE-PISTOOL 91 CM (345 BAR)	€ 184,00
16X668	G-FORCE-VERLENGSTUK 180 CM (275 BAR)	€ 49,00
116564	G-FORCE TELESCOPISCH VERLENGSTUK 180 – 550 CM (275 BAR)	€ 332,00
16X669	G-FORCE TELESCOPISCH VERLENGSTUK 180 – 730 CM (275 BAR)	€ 464,00
16X670	G-FORCE-RIEM VOOR TELESCOPISCHE VERLENGSTUKKEN	€ 59,00
16X665	SLANGHASPELSET, CAPACITEIT 30 M, 240 BAR	€ 1062,00
16X664	SLANGHASPELSET, CAPACITEIT 30 M, 345 BAR	€ 631,00
16E286	SLANG 3/8" X 7,5 M MET SCHROEFDRAAD (240 BAR)	€ #N/A
127534	SLANG 3/8" X 15 M MET SCHROEFDRAAD (240 BAR)	€ 203,00
244783	SLANG 3/8" X 15 M MET SNELKOPPELING (290 BAR)	€ 295,00
16X667	SLANG 3/8" X 30 M MET SNELKOPPELING (275 BAR)	€ 421,00
16X666	HORIZONTALE OPPERVLAKTEREINIGER, 45 CM (275 BAR)	€ 1095,00
16X680	HULPSTUK VOOR HET REINIGEN VAN DAKGOTEN (345 BAR)	€ 51,00
16X679	KOGELVENTIEL WATERAFSLUITER (275 BAR)	€ 117,00
801009	KOPPELING VOOR VERLENGSTUKKEN, 1/4"	€ 37,00
801568	QD-KOPPELING 3/8" (M) X 3/8" NPT (F) AS	€ 44,00
801569	QD-KOPPELING 3/8" (F) X 3/8" NPT (F) KOPPELING	€ 44,00
16X682	G-FORCE-ONDERDELENDOOS (345 BAR)	€ 437,00
287643	GARDENA® -WATERAANSLUITINGSADAPTER (MESSING)	€ 46,00

ACCESSOIRES PROFESSIONELE REINIGING



Verlengstukken, pistolen en rollers zijn modules die met de juiste wartelkoppen en adapters naar ieders behoefte kunnen worden aangepast.



WARTELKOPPELINGEN, NIPPELS, ADAPTERS, KOGELVENTIELEN

ARTIKELNUMMER	OMSCHRIJVING	EURO
KOPPELING PISTOOL		
U X I KOPPELING		
SCHROEFDRAAD, MAX. ARBEIDSDRUK.-BAR, DICHT. MAT-L, KOPPELING MAT.-L		
244515	1/4" NPT(M) X 1/4" NPSM(F), 210, LEDER, STAAL	€ 134,00
223341	1/4" NPT (M) X 1/4" NPSM(F), 250, PTFE, STAAL	€ 147,00
239663	1/4" NPT(M) X 1/4" NPSM(F), 250, LEDER, STAAL	€ 98,00
207947	1/2" NPT(M) X 1/2" NPT(F), 410, STAAL ZINK BESCHICHTET	€ 228,00
KOPPELING		
U X I KOPPELING		
SCHROEFDRAAD, MAX. ARBEIDSDRUK.-BAR, DICHT. MAT-L, KOPPELING MAT.-L		
156823	1/4" NPT(M) X 1/4" NPT(F), 690, STAAL	€ 22,00
157705	1/4" NPT (M) X 3/8" NPSM(F), 515, STAAL	€ 37,00
190451	1/2" NPT(M) X 1/2" NPSM(F), 206, STAAL	€ 18,00
I X I KOPPELING		
SCHROEFDRAAD, MAX. ARBEIDSDRUK.-BAR, DICHT. MAT-L, KOPPELING MAT.-L		
159153	1/4" NPT(F) X 3/8" NPT(F), 515, STAAL	€ 40,00
156173	3/8" NPSM(F) X 3/8" NPT(F), 510, STAAL	€ 40,00
161077	1/2" NPT(F) X 3/8" NPSM(F), 240, STAAL	€ 28,00
155865	1/2" NPSM(F) X 1/2" NPT(F), 500, STAAL	€ 65,00
HEX KOPPELING		
U X U KOPPELING		
SCHROEFDRAAD, MAX. ARBEIDSDRUK.-BAR, DICHT. MAT-L, KOPPELING MAT.-L		
162453	1/4" NPSM x 1/4" NPT NPSM, 515, STAAL	€ 10,00
156971	1/4" NPT x 1/4" NPT, 515, STAAL	€ 9,30
156849	3/8" NPT x 3/8" NPT, 500, STAAL	€ 3,70
196178	3/8" NPSM x 3/8" NPT, 350, STAAL E-NIKKEL COATING	€ 14,00
157350	3/8" NPT x 1/4" NPT, 413, STAAL	€ 16,00
158491	1/2" NPT X 1/2" NPT, 510, STAAL	€ 14,00



ARTIKELNUMMER	OMSCHRIJVING	EURO
REDUCEERKOPPELING U X U		
SCHROEFDRAAD, MAX. ARBEIDSDRUK.-BAR, DICHT. MAT-L, KOPPELING MAT.-L		
191872	1/8" NPT x 1/4" NPSM, 345, STAAL	€ 14,00
165274	1/4" NPT x 11/16"-27 UNS, 345, STAAL	€ 16,00
164856	3/8" NPT x 1/4" NPT, 550, EDELSTAAL	€ 40,00
164672	3/8" NPT x 1/4" NPSM, 413, STAAL	€ 22,00
196177	3/8" NPT x 1/4" NPSM, 415, STAAL E-NIKKEL COATING	€ 14,00
161800	3/4" NPT x 3/8" NPSM, 275, STAAL	€ 90,00
196142	3/4" NPT x 1/2" NPT, 345, STAAL	€ 39,00
158979	1/2" NPT x 3/8" NPT, 375, STAAL	€ 61,00
159239	1/2" NPT X 3/8" NPT, 510, STAAL	€ 14,00
ADAPTERS: U X I		
SCHROEFDRAAD, MAX. ARBEIDSDRUK.-BAR, DICHT. MAT-L, KOPPELING MAT.-L		
244825	1/4" NPT, 7/8"-14 UNP, 230, STAAL	€ 40,00
104969	1/2" NPT, 3/4" NPT, 275, STAAL	€ 65,00
181085	7/8"-14 UNF, 11/16"- 16 UNEF, 345, STAAL, PISTOOL EU - GRACO TIPHOUDER	€ 38,00
164120	11/16"- 16 UNEF, 7/8"-14 UNF-2B, 345, STAAL: GRACO PISTOOL - TIPHOUDER EU	€ 50,00
159841	1/4 NPT(F) X 3/8 NPT(M)	€ 35,00
T-STUK: I X I X U		
SCHROEFDRAAD, MAX. ARBEIDSDRUK.-BAR, DICHT. MAT-L, KOPPELING MAT.-L		
106228	2 X 1/4" NPT(F) X 1/4" NPT(M), 210, MESSING	€ 40,00
108673	2 X 3/8" NPT(F) X 3/8" NPT(M), 275, EDELSTAAL	€ 307,00
111337	2 X 3/4" NPT(F) X 3/4" NPT(M), 275, STAAL	€ 147,00
KOGELHAAN		
GEWINDE, MAX. ARBEIDSDRUK.-BAR, DICHT. MAT-L, KOPPELING MAT.-L		
239280	1/4" NPT (MBE), 350, FLUOROELASTOMER	€ 490,00
238694	3/8" NPT (MBE), 350, PTFE/SS	€ 611,00
223522	1/4" NPT(M) X DRILLED PLUG, 350, FLUOROELASTOMER	€ 586,00
224441	3/8" NPT(M) X DRILLED PLUG, 350, FLUOROELASTOMER	€ 298,00
238967	3/8" M NPT (MBE), 350, PTFE WITH PEEK SEAT	€ 684,00

TIPS



Gesorteerd op type tip
in alle beschikbare formaten

1. WAT VERTELT EEN SPUITTIP U? DE CODE GEKRAAKT!

Aan de **kleur** ziet u voor welke **toepassing** u een spuittip kunt gebruiken

-  Voor toepassingen met een fijne afwerking bij gebruik van dun materiaal met de **laagste druk**
-  Voor elke verklus binnen en buiten met de **laagste druk**
-  Voor het spuiten van wanden en algemene spuitklussen
-  Voor dunne bepleistering en minder vloeibare materialen
-  Voor beschermende coatings, tot 500 bar
-  Voor markerings- en belijningstoepassingen



5 Het **eerste cijfer** geeft de **spuitbreedte** van de spuittip aan

Het eerste cijfers van de code vermenigvuldigd met 5 vertelt u wat de spuitbreedte van de spuittip in cm is bij het spuiten op een afstand van 30 cm tot het oppervlak.

$$5 \times 5 = 25 \text{ cm}$$

17 De **laatste twee cijfers** staan voor de **materiaaluitvoer** van de spuittip

De laatste twee cijfers geven aan hoe groot de spuitopening is, in duizendsten van een inch. Hoe hoger het getal, hoe groter het debiet waarmee u kunt spuiten.

17' komt overeen met een opening van **0,017 inch**

2. HOE HOGER HET EERSTE CIJFER, HOE GROTER DE SPUITBREEDTE

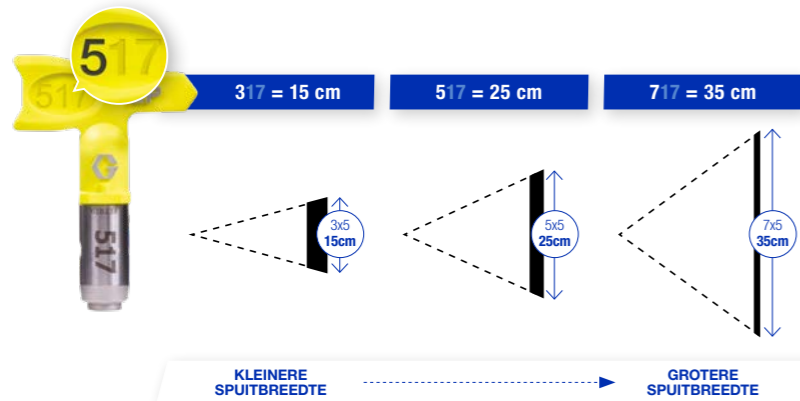

3. HOE HOGER DE LAATSTE TWEE CIJFERS, HOE HOGER DE MATERIAALUITVOER IS

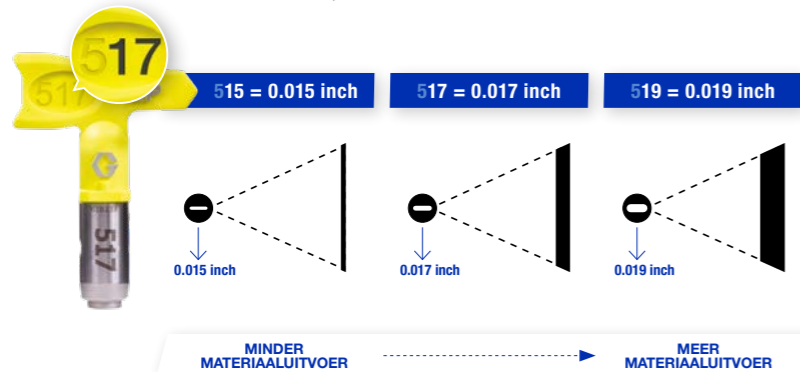

graco.com/tip

4. DE PRODUCTIVITEIT VERHOGEN MET TIPS

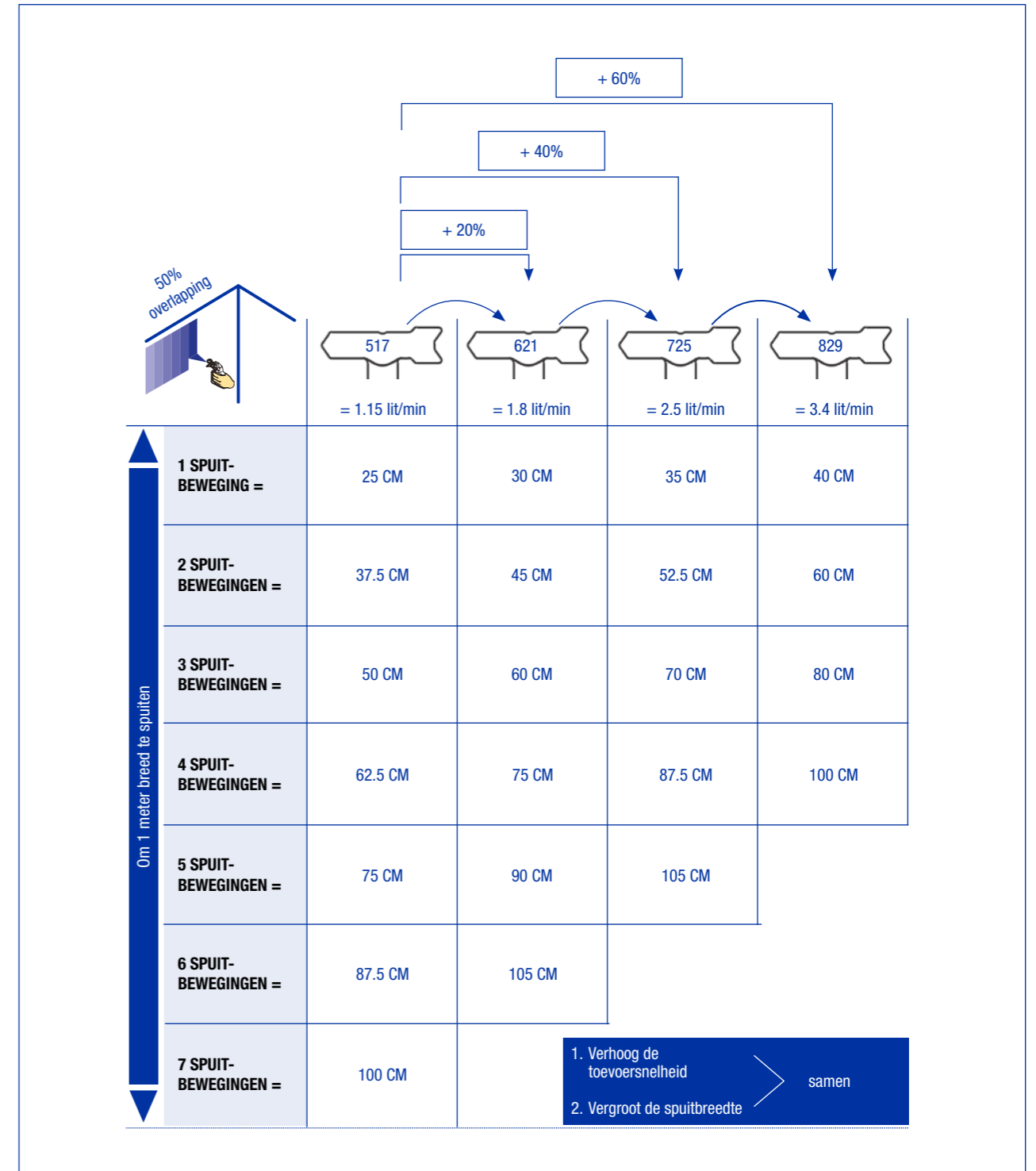

5. EEN TIP OVER TIPS

WAT IS TIPSLIJTAGE?

1 + 2

DE SPUITBREEDTE WORDT MINDER
= U moet meer spuitbewegingen maken
= **meer werk**

DE SPUITOPENING WORDT GROTER
= Er komt meer verf uit
= **hogere materiaalkosten**

=

TWEEMAAL ZOVEEL WERK!
+ 30% meer verf voor hetzelfde oppervlak!

WAT GEBEURT ER ALS EEN TIP SLIJT?

De twee belangrijkste oorzaken van tipslijtage zijn de werkdruk van het pistool en schurend materiaal.

Spuitbreedte neemt af:
> meer spuitbewegingen nodig
= **meer werk**

Grotere spuitopening:
> er komt meer verf uit het pistool
= **meer materiaalkosten**

2 keer zoveel werk
+ 30% meer verf voor hetzelfde oppervlak



TIPSLIJTAGETABEL:

NIEUW

1ste cijfer x 5
= spuitbreedte*

5 cm
10 cm
15 cm
20 cm
25 cm
30 cm
35 cm
40 cm
60 cm

*op 30 cm spuitafstand

VERSLETEN

tijd om te vervangen!

3 cm
7 cm
10 cm
15 cm
20 cm
25 cm
30 cm
35 cm
55 cm

SELECTIEGIDS SPUITTIPS

MATERIAALDIKTE	MATERIALEN VOORBEELD	AANBEVOLEN TIP-FORMATEN		OVERZICHT AIRLESS TIPS	TIPHOUDERS
FIJN					
20-30% vaste stof	Verf	007-009	008-010	163xxx (zilver)	220251
	Beitsen	009-011	008-012	163xxx (zwart)	
	Lakken	011-013	012-014	LTXxxx RAC® X (blauw)	RAC® X - 246215
	Oliën	011-013	012-014		
	Glazuren	011-015	012-014	FFLPxxx RAC® X (groen)	
	Urethaan	013-015	012-014		
GEMIDDELD					
30-50% vaste stof	Latex	015-019	014-020	269xxx Contractor™ Plat	
	Acrylverf	015-019	014-020	163xxx (zilver)	RAC® X - 246215
	Meerkleuren	024-031		FFLPxxx / LPxxx / WRLPxxx RAC® X (neon)	
	Emulsies	017-021	018-020	PAAxxx RAC® X (blauw)	
ZWAAR					
50% + vaste stof	Blokvullers	023-031		163xxx (zilver)	220251
	Elastomeren	025-033			
	Brandvertragende materialen	029-035		LPxxx / WRLPxxx RAC® X (neon)	RAC® X - 246215
	Spachtel	029-065			
	Mastieken	041-047			
	Epoxy's	031-043		HDAxxx RAC® X (bruin)	
	Vezels	047-053			
	Asfalt	031-067		WAxxx RAC® X (blauw)	
SPECIALTY					
Airless Striping	Verf om wegen te belijnen	031-039		LL5xxx RAC® V (geel) or 163xxx	RAC® V - 243161

PRIJSLIJST EURO

INNOVATIEVE LAGE DRUK SMARTTIP™ TECHNOLOGIE, ONTWIKKELD OM DE BESTE AFWERKING IN DE INDUSTRIE TE LEVEREN!

Bevat Graco's gepatenteerde RAC® X Tip with **SMARTTIP™ TECHNOLOGIE** met interne exclusieve spuittip geometrie en levert de beste afwerking in de industrie met de laagste airless spuitdruk!

INNOVATIEVE ATOMIZERING

- Mogelijkheid om te spuiten met lage druk zonder randen
- Betere afwerking onder alle spuitdrukken - werkt goed met moeilijk te atomiseren lage VOC materialen

INNOVATIEVE BETROUWBAARHEID

- Spuittip gaat langer mee bij gebruik onder lage druk
- Minder slijtage op de spuitmachine

INNOVATIEVE VEELZIJDIGHEID

- Langere slanglengtes
- Kleinere slangdiameters

SMARTTIP™ TECHNOLOGIE is ontwikkeld samen met Graco's exclusieve **SMARTCONTROL™ PRESSURE MANAGEMENT SYSTEEM** om een superieur spuitbeeld te verkrijgen zonder drukvariaties op elke spuitdruk!

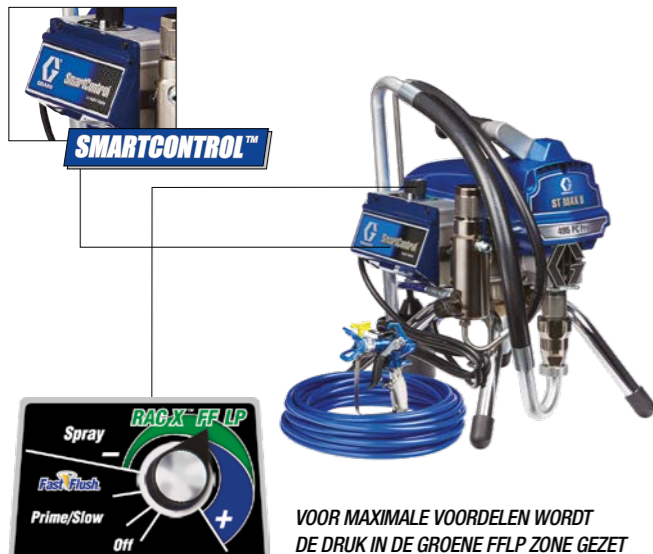

**LAGE DRUK
TECHNOLOGIE
UITGEBREID NAAR
GROTERE MATEN!**

LAGE DRUK TIPS

FIJNE AFWERKINGTIPS, LAGE DRUK



FFLPXXX		RAC® X - GROEN						98,00 €
		SPUITBREEDTE						
Grootte	Debiet Lpm	5 cm	10 cm	15 cm	20 cm	25 cm	30 cm	
.006	.15	106	206					
.008	.26	108	208	308	408			
.010	.41	110	210	310	410	510		
.012	.59	112	212	312	412	512		
.014	.80		214	314	414	514		
.016	1.04					516	616	



21A106 Control Spray Starter Kit- 200 mesh pistoolfilters, 200 mesh pompfilter, FFLP106 tip
21A206 Control Spray Starter Kit- 200 mesh pistoolfilters, 200 mesh pompfilter, FFLP206 tip

LAGE DRUK TIPS



LPXXX		RAC® X - NEON					98,00 €
		SPUITBREEDTE					
Grootte	Debiet Lpm	10 cm	15 cm	20 cm	25 cm	30 cm	35 cm
.013	.69		313				
.015	.91		315	415	515		
.017	1.17	217	317	417	517	617	
.019	1.47		319	419	519	619	
.021	1.79			421	521	621	
.023	2.15			423	523	623	723
.025	2.54			425	525	625	725
.027	2.96				527	627	
.029	3.42					629	729
.031	3.90					631	731

WIDE RAC LAGE DRUK TIPS



WRLPXXX		RAC® X - NEON						107,00 €
		SPUITBREEDTE						
Grootte	Debiet Lpm	10 cm	20 cm	30 cm	40 cm	50 cm	60 cm	
.021	1.8						1221	
.023	2.15						1223	
.025	2.5						1225	
.027	3.0						1227	
.029	3.4						1229	
.031	3.9						1231	
.033	4.4						1233	



PROFESSIONELE AIRLESS TIPS



PAAXXX RAC X - BLAUW 86,00 €

Grootte	Debiet Lpm	SPUITBREEDTE							
		5 cm	10 cm	15 cm	20 cm	25 cm	30 cm	35 cm	40 cm
.015	.90	115	215	315	415	515	615		
.017	1.15		217	317	417	517	617		817
.019	1.5		219	319	419	519	619		819
.021	1.8		221	321	421	521	621	721	821
.023	2.15			323	423	523	623	723	
.025	2.5		225	325	425	525	625		



LTXXXX RAC X - BLAUW 86,00 €

Grootte	Debiet Lpm	SPUITBREEDTE					
		10 cm	15 cm	20 cm	25 cm	30 cm	35 cm
.007	.20		207				
.009	.33	109	209	309	409	509	
.011	.49	111	211	311	411	511	611
.013	.69		213	313	413	513	613



HEAVY DUTY TIPS



HDAXXX RAC X - BRUIN 86,00 €

Grootte	Debiet Lpm	SPUITBREEDTE							
		10 cm	15 cm	20 cm	25 cm	30 cm	35 cm	45 cm	
.027	2.96	227	327	427	527	627		827	
.029	3.42		329	429	529	629	729		
.031	3.90	231	331	431	531	631		831	
.033	4.42			433	533	633		833	
.035	4.98	235	335	435	535	635	735	835	
.037	5.56				537	637			
.039	6.18			439	539	639			
.041	6.83			441	541	641			
.043	7.51			443	543	643			
.045	8.23			445	545	645			
.047	8.98				547	647			
.051	10.67			451	551	651			
.055	12.29			455	555	655			
.061	15.12				561	661			
.065	17.17					665			
.071	20.48					671			

WIDE RAC TIPS



WRXXXX RAC X - BLAUW 96,00 €

Grootte	Debiet Lpm	SPUITBREEDTE					
		10 cm	20 cm	30 cm	40 cm	50 cm	60 cm
.021	1.8						1221
.023	2.15						1223
.025	2.5						1225
.027	3.0						1227
.029	3.4						1229
.031	3.9						1231
.033	4.4						1233
.035	5.0						1235
.037	5.55						1237
.039	6.2						1239

FIJNE AFWERKINGTIPS



163XXX		PLATTE TIPS, ONEVEN									80,00 €
Grootte	Debiet Lpm	SPUITBREEDTE									
		5 cm	10 cm	15 cm	20 cm	25 cm	30 cm	35 cm	40 cm	45 cm	
.007	.20	107	207	307							
.009	.33	109	209	309	409	509	609				
.011	.49	111	211	311	411	511	611	711			
.013	.69	113	213	313	413	513	613	713	813		
.015	.91	115	215	315	415	515	615	715	815	915	
.017	1.17	117	217	317	417	517	617	717	817	917	
.019	1.47	119	219	319	419	519	619	719	819	919	
.021	1.79	121	221	321	421	521	621	721	821	921	
.023	2.15		223	323	423	523	623	723	823	923	
.025	2.54		225	325	425	525	625	725	825	925	
.027	2.96		227	327	427	527	627	727	827	927	
.029	3.42		229	329	429	529	627	729	829	929	
.031	3.90		231	331	431	531	631	731	831	931	



163XXX		PLATTE TIPS, EVEN									117,00 €
Grootte	Debiet Lpm	SPUITBREEDTE									
		5 cm	10 cm	15 cm	20 cm	25 cm	30 cm	35 cm	40 cm	45 cm	
.008	.26	108	208		408						
.010	.41		210	310	410	510	610				
.012	.59		212	312	412	512	612	712		912	
.014	.79		214	314	414	514	614	714	814		
.016	1.04		216	316	416	516	616	716	816		
.018	1.32			318	418	518	618	718	818	918	
.020	1.63				420	520	620		820		
.022	1.97					522	622		822	922	
.024	2.34				424		624		824	924	
.026	2.75						626		826		
.032	4.16				432				832		



269XXX		PLATTE CONTRACTOR TIPS								46,00 €
Grootte	Debiet Lpm	SPUITBREEDTE								
		10 cm	15 cm	20 cm	25 cm	30 cm	35 cm	40 cm	45 cm	
.011	.50	211	311	411	511					
.013	.70	213	313	413	513	613				
.015	.90	215	315	415	515	615	715	815		
.017	1.15	217	317	417	517	617	717			
.019	1.5	219	319	419	519	619	719	819		
.021	1.8		321	421	521	621	721	821		
.023	2.15		323	423	523	623				
.025	2.5	225	325	425	525	625	725		925	
.027	3.0	227	327	427	527	627		827		
.029	3.4							829		
.031	3.9				531	631		831		
.035	5.0			435		635				

HEAVY DUTY TIPS



163XXX		PLATTE TIPS HEAVY DUTY									80,00 €
Grootte	Debiet Lpm	SPUITBREEDTE									
		5 cm	10 cm	15 cm	20 cm	25 cm	30 cm	35 cm	40 cm	45 cm	
.033	4.42				433		633	733	833	933	
.035	4.98		235	335	435	535	635	735	835	935	
.037	5.56						637	737			
.039	6.18	139	239	339	439	539	639		839	939	
.041	6.83			341	441	541	641		841		
.043	7.51				443	543	643	743	843	943	
.045	8.23			345	445	545	645		845		
.047	8.98			347		547	647		847		
.049	9.76				449		649	749	849		
.051	10.67			351	451	551	651	751			
.053	11.41							753			
.055	12.29				455	555	655	755	855		
.057	13.20			357	457	557	657	757			
.059	14.14				459						
.061	15.12				461	561	661	761	861		
.063	16.13				463	563	663	763			
.065	17.17				465	565	665		865		
.067	18.24				467	567	667	767	867		
.069	19.34						669				
.071	20.48				471	571	671	771	871		
.077	24.00				477						
.081	26.66				481						

220251





LL5XXX

RAC V - GEEL

138,00 €

Lijnbreedte	Debiet Lpm	SPUITBREEDTE			
		5 cm	10 cm	15 cm	30 cm
.013	.69	213			
.015	.91	215	315		
.017	1.17	217	317	417	
.019	1.47	219	319	419	
.021	1.79		321	421	621
.023	2.15		323	423	623
.025	2.54		325	425	625
.027	2.96		327	427	627
.029	3.42		329	429	629
.031	3.90		331	431	631
.033	4.42		333		
.035	4.98		335	435	635
.039	6.18		339	439	639
.043	7.51		343	443	643
.055	12.29		355		



RAC® V - 243161



805XXX

TIPS MET SNELKOPPELING HOGEDRUKREINIGER

26,00 €

Grootte	SPUITHOEK				
	0°	15°	25°	40°	SET OF 4 TIPS (0°-15°- 25°- 40°)
2.7	805591	805592	805593	805594	-
3.0	805535	805536	805537	805538	244768
3.5	805539	805540	805541	805542	244769
3.7	805595	805596	805597	805598	-
4.0	805543	805544	805545	805546	800708
4.5	805547	805548	805549	805550	800709
5.0	805551	805552	805553	805554	800710
5.5	805555	805556	805557	805558	-

Chemical Tip | 805634



805XXX

SAND WASHER TIPS

32,00 €

Grootte	SPUITHOEK			
	0°	15°	25°	40°
3.0	-	805305	-	-
4.0	805312	805313	-	805315
4.5	805316	805317	805318	805319
5.0	805320	805321	-	-
5.5	805324	805325	-	-
5.8	805328	805329	805330	805331



191,00 €
198012 ROTERENDE SPUITTIP VOOR HOGEDRUKREINIGERS (275 BAR)

375,00 €
198014 ROTERENDE SPUITTIP VOOR HOGEDRUKREINIGERS (360 BAR)

327,00 €
198013 OSCILLERENDE SPUITTIP VOOR HOGEDRUKREINIGERS (345 BAR)



387,00 €
244766 ZANDSTRAALSET(380 BAR)

5 years	2 years	1 year
gear box electric motor	electrical parts	hard parts

* Handhelds, Ultra QuickShot and GX excluded. See full warranty details on contractorclub.eu

WARRANTY

GARANTIE

	5 JAREN	2 JAREN	1 JAAR
MACHINES	■ CHASSIS	■ REGELKAST & COMPONENTEN	■ ULTRA AIRLESS HANDHELD & ULTRAMAX AIRLESS HANDHELD
	■ AANDRIJFSYSTEEM	■ ELECTRISCHE COMPONENTEN	■ ULTRA QUICKSHOT
	■ ELEKTROMOTOREN (UITGEZONDERD HANDHELDS, ULTRA QUICKSHOT EN GX)	■ TURBINES	■ VLOEISTOFSECTIE
	■ HARDE ONDERDELEN VAN DE HYDRAULISCHE MOTOR	■ KOPPELING	■ HONDA GC MOTOR
	■ RIEMAANGEDREVEN WATER POMPEN	■ HARDE ONDERDELEN VAN DE ONDERPOMP	■ HYDRAULISCHE GROUP
	■ DIRECT AANGEDREVEN WATER POMP*	■ THERMISCH ONTLASTINGSVENTIEL	■ GAS GROUP
		■ ONTLAADKLEP	■ POWERFILL
		■ GX	
ACCESSOIRES			■ PISTOOLBEHUIZINGEN & BEVESTIGINGEN
VERBRUIKSONDERDELEN			Graco dekt geen verbruiksonderdelen: tips, filters, pakkingen, reparatiesets, zittingen, kogels, borstels.
OVERIGE GARANTIES			Componenten die niet zijn gefabriceerd door Graco worden gedekt door hun eigen garantie: benzinemotoren, slangen, waterpompen. Voor alle Graco-producten geldt een garantiedekking van één jaar met betrekking tot fabricagefouten. Zie het "Blauwe Boek" (documentnr. B0170) voor volledige gedetailleerde informatie over de voorwaarden van Graco (garantie, transport, retouren, enz.).

* Voor machines verkocht vanaf 2019

SALES BOOK Graco's verkooptool!

ALTIJD, OVERAL EN OFFLINE



 AFBELDINGEN EN VIDEO'S

 PRESENTATIES

 COMMERCIËLE EN
TECHNISCHE LITERATUUR

ONDERSTEUNINGS- MATERIAAL

Speciaal op maat gemaakt ondersteuningsmateriaal ter beschikking van onze handelaars om Graco's producten te presenteren, te helpen gebruiken en erover te communiceren.

COMMERCIELE LITERATUUR & SERVICE INFORMATIE

OMSCHRIJVING	ARTIKELNUMMER	CODE	BG	CS	DA	DE	ENEU	EL	ES	ET	FI	FR	HR	HU	IT	LT	LV	NL	NO	PL	PT	RO	RU	SL	SR	SV	TR	
		Taal	Bulgaars	Tsjechisch	Deens	Duits	Engels	Grieks	Spaans	Estlands	Fins	Frans	Croatisch	Hongaars	Italiaans	Lithouws	Lets	Nederlands	Noors	Pools	Portugees	Roemeens	Russisch	Sloveens	Servisch	Zweeds	Turks	
Kleine Klussen	3J0545		■	■	■	■	■	■	■			■			■			■	■	■			■			■		
PowerShot	3J0652			■	■	■	■	■	■			■			■			■	■	■			■			■	■	
HVLP	300744		■	■	■	■	■	■	■			■			■			■	■	■			■			■	■	
FinishPro II Pc Pro	320599		■	■	■	■	■	■	■	■	■	■			■			■	■	■	■			■		■	■	
GX	300735		■	■	■	■	■	■	■	■	■	■			■			■	■	■	■			■		■	■	
Betoninjectiesystemen	300736					■	■	■	■			■			■			■	■	■			■			■	■	
Classic PC	300733		■	■	■	■	■	■	■	■	■	■			■			■	■	■	■			■		■	■	
ST Max II PC Pro	320580		■	■	■	■	■	■	■	■	■	■			■			■	■	■	■			■		■	■	
Ultra Max II	300713		■	■	■	■	■	■	■	■	■				■			■	■	■	■			■		■	■	
Ultra XT	3J0616			■	■	■	■	■	■			■			■			■	■	■	■			■		■	■	
Mark HD 3-IN-1	300716		■	■	■	■	■	■	■	■	■	■			■			■	■	■	■			■		■	■	
Mark XT	3J0626			■	■	■	■	■	■			■			■			■	■	■	■			■		■	■	
°C-Max	300696			■	■	■	■	■	■			■			■			■	■	■	■			■		■	■	
Gmax II HD 3-IN-1 Standard	300718			■	■	■	■	■	■			■			■			■	■	■	■			■		■	■	
Gmax II HD 3-IN-1 ProContractor	300719			■	■	■	■	■	■			■			■			■	■	■	■			■		■	■	
Gmax II HD 3-IN-1 Ironman	300769			■	■	■	■	■	■			■			■			■	■	■	■			■		■	■	
DutyMax HD 3-IN-1 Standard	300722				■	■	■	■	■			■			■			■	■	■	■			■		■	■	
DutyMax HD 3-IN-1 ProContractor	300723				■	■	■	■	■			■			■			■	■	■	■			■		■	■	
GH BIG RIG	320593				■	■	■	■	■			■			■			■	■	■	■			■		■	■	
T-Max	320596		■	■	■	■	■	■	■			■			■			■	■	■	■			■		■	■	
RTX	300661		■	■	■	■	■	■	■			■			■			■	■	■	■	■			■		■	
FastFinish	300760			■	■	■	■	■	■			■			■			■	■	■	■			■		■	■	
APX	300743				■	■	■	■	■			■			■			■	■	■	■			■		■	■	
Powerfill	300795		■		■	■	■	■	■	■	■	■			■			■	■	■	■			■		■	■	
G-Force II	320582			■	■	■	■	■	■			■			■			■	■	■	■			■		■	■	
Onderhoudsoplossing voor wegmarkeringen	300720				■	■	■	■	■			■			■			■	■	■	■			■		■	■	
GrindLazer	341251				■	■	■	■	■			■			■			■	■	■	■			■		■	■	
Airless Accessories	300672			■	■	■	■	■	■			■			■			■	■	■	■			■		■	■	
Airless Tips	300666		■	■	■	■	■	■	■			■			■			■	■	■	■			■		■	■	
Ultra Airless Handheld Beknopte handleiding	16T305					■	■	■	■																			
Ultra Airless HandHeld Corded Beknopte handleiding	300759					■	■	■	■																			
HVLP TurboForce II Beknopte handleiding	328034					■	■	■	■																			
FinishPro II 395 PC Beknopte handleiding	328035					■	■	■	■																			
GX Beknopte handleiding	300752					■	■	■	■																			
Classic 390PC Beknopte handleiding	300749					■	■	■	■																			
Classic S 395PC - 495PC Beknopte handleiding	300750					■	■	■	■																			
ST Max II PC Pro Beknopte handleiding	328007					■	■	■	■																			
Ultra Max II ProC. & Mark Max ProC. Beknopte handleiding	328006					■	■	■	■																			
GMax II Beknopte handleiding	328009					■	■	■	■			■			■													
DutyMax Beknopte handleiding	300751					■	■	■	■																			
T-Max 506/657 Beknopte handleiding	328033					■	■	■	■																			
APX Beknopte handleiding	300748					■	■	■	■																			
Snel problemen verhelpen	314980		■	■	■	■	■	■	■			■	■	■	■	■	■	■	■	■	■			■	■	■	■	■
Onderhoudsboekje	300663			■	■	■	■	■	■			■	■	■	■	■	■	■	■	■	■			■	■	■	■	■
Onderhoudssticker (6)	ZZXXXX			ZZ2005	ZZ1674	ZZ1672			ZZ1677			ZZ1676			ZZ1675			ZZ1673										

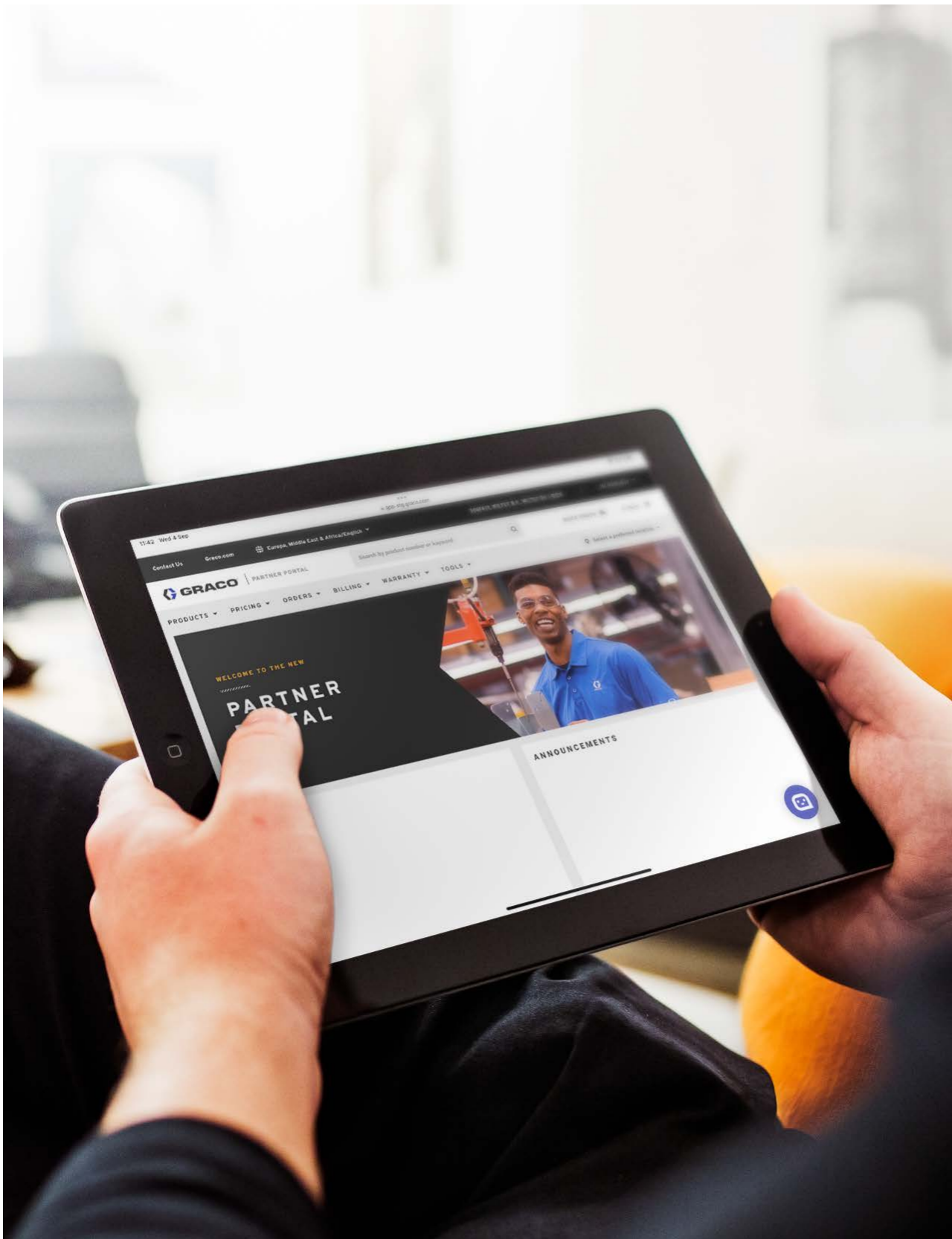

WAT IS HET GRACO PARTNER PORTAL?

Het Partner Portal is een algemene tool waarmee u naadloos zaken kunt doen met Graco. Het biedt veilige online toegang tot productinformatie zoals actuele prijzen en beschikbaarheid, het kan worden gebruikt om bestellingen te plaatsen en de verzendstatus te bekijken, en nog veel meer.

Kenmerken en voordelen

- > Bestellingen plaatsen
- > Catalogusprijs, nettoprijs, beschikbaarheid van producten en bestelstatus bekijken
- > Uw rekeningsaldo beheren
- > Garantieclaims bekijken, wijzigen of indienen
- > Extra gebruikers toegang geven tot uw Graco-account
- > Zoeken naar literatuur en instructiehandleidingen
- > Producten vergelijken
- > Op elk moment verbinding met Graco via uw mobiele apparaat of computer

Wat is er veranderd ten opzichte van CIS?

- > **Werkt perfect op mobiele apparaten:** naadloze gebruikerservaring op mobiele apparaten.
- > **Gebruikersbeheer:** Met uitgebreide gebruikersrechten krijgen meer gebruikers toegang tot de website.
- > **Graco bot:** 24/7 ondersteuning via de chatoptie
- > **Producten bestellen:** direct bestellen vanaf productpagina's via de winkelwagen
- > **Bestellingen en garantie:** snel proces voor het importeren van bestellingen en een verbeterd garantieproces, waardoor bijlagen direct in de claim kunnen worden geüpload
- > **Zoeken:** verbeterde zoekfunctie en toegang tot handleidingen en brochures.
- > **Winkelen en Vergelijken:** blader door de productcatalogus en gebruik de vergelijkingstool voor producten.
- > **Visueel ontwerp:** afgestemd op het merk zodat het aansluit bij graco.com



ONZE BELOFTE AAN U

Sinds 1926 staan innovatie, kwaliteit en A+ dienstverlening centraal bij Graco.

Innovatie door ervaring

Onze focus op innovatie leidt tot producten en apparatuur die toonaangevend zijn in de industrie, dankzij technologisch geavanceerde functies, een baanbrekend ontwerp, hoge prestaties en ongeëvenaarde betrouwbaarheid. Kortom, innovatie is de manier om betere producten te krijgen!

Betrouwbare kwaliteit

U investeert in producten van hoge kwaliteit die jaren meegaan. Bovendien werken we samen met onze klanten om beter te begrijpen hoe u onze producten in de praktijk inzet, om vervolgens uw ervaringen te gebruiken om de prestaties en duurzaamheid te verbeteren.



A+ dienstverlening, telkens weer

U ziet A+ dienstverlening in actie wanneer u contact opneemt met een van onze ondersteuningdiensten, ongeacht waar ter wereld u zich bevindt. We luisteren naar uw situatie en werken methodisch om het zo snel mogelijk op te lossen. We laten ons leiden door een mindset van integriteit en klantenservice gericht op samenwerking en relaties, niet op transacties.



We zijn er om uw vragen te beantwoorden en aan uw vereisten te voldoen:
www.graco.com/contact

Graco is ISO 9001-gecertificeerd.

©2012 Graco Distribution BV 314253NL-V 12/24 Gedrukt in Europa.

Alle teksten en afbeeldingen in dit document zijn gebaseerd op de meest recente productinformatie zoals beschikbaar op het tijdstip van publicatie. Graco behoudt zich het recht voor om te allen tijde wijzigingen aan te brengen zonder voorafgaande kennisgeving. *Alle andere merknamen of merken worden voor identificatiedoeleinden gebruikt en zijn handelsmerken van hun betreffende eigenaars. Ga voor meer informatie over het intellectuele eigendom van Graco naar www.graco.com/patent of www.graco.com/trademarks.